



2019

Katalóg strojov Makita



Platný od 1. 4. 2019 do 31. 3. 2020

Sortiment aku strojov do záhrady



18V X2

36V



ROŠIRTE SI SVOJ AKU SORTIMENT

CHAINSaws: DUC405 / DUC400 / DUC355 / DUC353 / DUC305 / DUC303 / DUC302 / DUC252 / DUC252C

Brushcutters: DHR263 / DHR264

Blowers: DUB361 / DUB362

Pruners: DLM460 / DLM431 / DLM380

Drills: DHR280, DHR282+DX08 / DHR281, DHR283+DX09

Impact Drivers: DHR400N

Angle Grinders: DGA701 / DGA901 / DGA700 / DGA900

Reciprocating Saws: DJR360

Skid Steer Loader: DLW140

Hand Saws: DLS714 / DLS110 / DLS111 / DLS112 / DLS211 / DLS212

Table Saws: DHS710 / DHS711 / DHS781 / DHS780

Circular Saws: DRS780

Skid Steer Loader: DSP600 / DSP601

Generators: DVC862L / DVC863L / DVC864L

Generators: DVC261 / DVC265

Generators: DDA460

Generators: DWT310

Generators: BAP182

Generators: BCV01

Generators: DUC860L / DUC861L

Generators: BCV03

Generators: DUX60

Generators: DUR366L / DUR365U / DUR364L / DUR362L / DUR361U

Generators: DUH551 / DUH651

Generators: DUX60

Generators: DUP361 / DUP362

Generators: DVC860L / DVC861L

OBSAH

1	9046	99	BO5031	100	DA332DZ	38	DCV202Z2XL	47
1806B	110	9237CB	92	BO5041	100	DA333DSAE	38	DCV202ZL
1911B	111	9403J	98	BO6030	100	DA333DZ	38	DCV202ZXL
2	9404J	98	BO6050J	100	DA4000LR	64	DDA350Z	22
2012NBX	111	9557HNRG	89	C	DBM080	65	DDA351Z	22
2107FK	85	9558HNRG	89	CA5000XJ	86	DBM130	65	DDA460Z
2704N	104	9558HNRGK	89	CC301DSMJ	39	DBM131	65	DDF083RFJ
2712	104	9558HNRX1	89	CC301DZ	39	DBM230	65	DDF083Z
3	9565CR	88	CF101DZ	41	DBO180Z	27	DDF453RFE	17
3709	112	9565CVR	88	CG100DSAA	42	DCF102Z	44	DDF453SFX1
3710	112	9741	98	CG100DZA	42	DCF201Z	44	DDF453SYE
4	9903	98	CJ105DZ2XL	47	DCF300Z	44	DDF458RF3J	16
4100KB	83	9910	97	CJ105DZL	47	DCG180RF	32	DDF458Z
4112HS	83	9911	97	CJ105DZM	47	DCG180Z	32	DDF481RTJ
4112HS	121	9924DB	98	CJ105DZXL	47	DCJ200Z2XL	46	DDF481Z
4131	84	A	CJ106DZ2XL	47	DCJ200ZXL	46	DDF482RFEB	16
4326	107	AC1300	118	CJ106DZL	47	DCJ205Z2XL	46	DDF482RFJ
4327	107	AC1350	118	CJ106DZM	47	DCJ205ZL	46	DDF482Z
4329	107	AC310H	118	CJ106DZXL	47	DCJ205ZM	46	DDF483RFJ
4350FCTJ	107	AC640	118	CL070DS	51	DCJ205ZXL	46	DDF483RTJ
4351FCTJ	107	AF201Z	120	CL104DWY	51	DCJ206Z2XL	47	DDF483Z
5	AF505N	120	CL106FDWM	50	DCJ206ZL	47	DDF484RFJ	16
5103R	106	AN902	119	CL106FDZ	50	DCJ206ZM	47	DDF484Z
5143R	106	AN943K	119	CL107FDZ	50	DCJ206ZXL	47	DDF485RFJ
5903R	105	AN960	119	CL108FDWA	51	DCL180Z	50	DDF485Z
6	AT1150A	120	CL108FDZ	51	DCL182Z	50	DEADML185	43
6408	63	AT2550A	119	CL183DZ	50	DCL501Z	51	DEADML186
6412	63	AT638A	119	CLX201SAX6	126	DCM501Z	45	DEADML801
6413	63	B	CP100DWA	40	DCS551Z	25	DEADML802	43
6906	68	BO3710	99	CV101DZ2XL	47	DCS552RTJ	24	DEADML805
6953	68	BO3711	99	CV101DZL	47	DCS552Z	24	DEAML103
7	BO4555	99	CV101DZM	47	DCS553RTJ	25	DEAML104	43
7104L	113	BO4557	100	CV101DZXL	47	DCS553Z	25	DEAML105
9	BO4565K	99	D	DCU180Z	8	DF001DW	53	
9031	97	BO4900VJ	99	DA3010F	64	DCU180Z + 199008-0	8	DF012DSE
9032	97	BO5030	100	DA332DSAE	38	DCU180Z + 199009-8	8	DF032DSAE



DF032DSME	37	DFL082FZ	58	DHP453SYE	18	DJN161Z	26	DP2010	63
DF032DZ	37	DFL083FZ	58	DHP458RTJ	18	DJR181RTE	29	DP4003	63
DF033DSAE	37	DFL201FZ	58	DHP458Z	18	DJR181Z	29	DP4010	64
DF033DZ	37	DFL202FZ	58	DHP481RTJ	17	DJR183RTJ	30	DP4011	64
DF331DSAE	37	DFL204FZ	59	DHP481Z	17	DJR183Z	30	DP4700	64
DF331DSAX6	37	DFL301FZ	59	DHP482RFJ	18	DJR186RTE	30	DPJ180Z	31
DF332DSAE	37	DFL302FZ	57	DHP482Z	18	DJR186Z	30	DPT353RFJ	32
DF332DSME	37	DFL402FZ	59	DHP483RFJ	19	DJR187RTE	30	DPT353Z	32
DF332DZ	37	DFL403FZ	58	DHP483Z	19	DJR187Z	30	DRC200Z	50
DF333DSAE	37	DFL651FZ	59	DHP484RFJ	18	DJR188RTJ	30	DRT50RTJX2	31
DF333DSME	37	DFR550RFE	23	DHP484Z	18	DJR188Z	30	DRT50ZJX2	31
DF333DZ	37	DFR550Z	23	DHP485RFJ	18	DJR360PT2	11	DRT50ZX4	31
DF457DWE	53	DFS251RTJ	23	DHP485Z	18	DJR360Z	11	DS4012	64
DF457DWLX1	53	DFS251Z	23	DHR171RTJ	24	DJS101RFJ	25	DSC102Z	24
DFJ206Z2XL	45	DFS452Z	23	DHR171Z	24	DJS130RFE	25	DSC250RT	25
DFJ206Z3XL	45	DFT023FMZ	57	DHR202RTJ	24	DJV180Z	29	DSC250ZK	25
DFJ206ZL	45	DFT045FZ	57	DHR202Z	24	DJV181RTJ	29	DSC251RT	25
DFJ206ZXL	45	DFT085FMZ	57	DHR241RTJ	23	DJV181Z	29	DSD180Z	30
DFJ207Z2XL	45	DFT127FZ	57	DHR241Z	23	DJV182Z	29	DSP600ZJ	10
DFJ207ZL	45	DFV210Z2XL	46	DHR243RTJW	23	DK0053G	126	DSP601ZJU	10
DFJ207ZXL	45	DFV210ZL	46	DHR243Z	23	DKP180RTJ	31	DSS610Z	29
DFJ212Z2XL	45	DFV210ZXL	46	DHR263PT2J	9	DKP180Z	31	DST112Z	33
DFJ212ZL	45	DGA452RTJ	27	DHR263Z	9	DLM380PT2	13	DST221Z	32
DFJ212ZXL	45	DGA452Z	27	DHR264PT2J	10	DLM380Z	13	DTD152RTJ	20
DFJ213Z2XL	45	DGA504RTJ	26	DHR264Z	10	DLM431PT2	13	DTD152Z	20
DFJ213ZL	45	DGA504ZJ	26	DHR280Z	9	DLM431Z	13	DTD153RFJ	19
DFJ213ZXL	45	DGA506RTJ	26	DHR282T2JU	9	DLM460PT2	13	DTD153Z	19
DFJ304Z2XL	46	DGA506ZJ	26	DHR282ZU	9	DLM460Z	13	DTD154RTJ	19
DFJ304Z3XL	46	DGA511RFJ	26	DHR400PT4U	9	DLS111ZU	10	DTD154Z	19
DFJ304ZL	46	DGA511Z	26	DHR400ZKU	9	DLS600Z	28	DTD155Z	20
DFJ304ZXL	46	DGA513RTJ	26	DHS630RTJ	28	DLW140Z	10	DTD170RTJ	19
DFJ305Z2XL	46	DGA513ZJ	26	DHS660RTJ	28	DLX2126TJ1	126	DTD170Z	19
DFJ305ZL	46	DGA518ZJU	27	DHS660ZJ	28	DLX2133	126	DTD171RTJ	19
DFJ305ZXL	46	DGA900PT2	8	DHS661RTJU	28	DLX2153TJ1	126	DTD171Z	19
DFJ405Z2XL	46	DGA900Z	8	DHS661ZJU	28	DLX3078TX1	126	DTL063RTJ	22
DFJ405ZL	46	DGA901T2U1	8	DHS680RTJ	28	DLX6037	126	DTM51RFJX1	27
DFJ405ZXL	46	DGA901ZUX1	8	DHS680Z	28	DMR107	48	DTM51Z	27
DFJ407Z2XL	46	DGD800RTJ	27	DHS710PT2J	10	DMR108	48	DTR180ZJ	22
DFJ407ZL	46	DGD800Z	27	DHS710Z	10	DMR110	48	DTS141Z	20
DFJ407ZXL	46	DHP453RFE	18	DJN161RFJ	26	DMR202	49	DTW1001RTJ	20

DTW1001Z	20	DUP361Z	12	GA5040R	89	HM1213C	77	HR2800	74
DTW1002RTJ	21	DUR181Z	34	GA5040RZ1	89	HM1214C	78	HR2810	74
DTW1002Z	21	DUR184LZ	34	GA5041C01	88	HM1307C	78	HR2810T	73
DTW180RFJ	22	DUR187LZ	34	GA6021	89	HM1307CB	78	HR2811FT	73
DTW180Z	22	DUR187UZ	34	GA6021C	88	HM1317C	78	HR3200C	74
DTW181RTJ	21	DUR188UZ	34	GA6040C01	88	HM1317CB	78	HR3210C	74
DTW181Z	21	DUR189Z	33	GA7012C	91	HM1802	79	HR3210FCT	74
DTW190JX3	22	DUR365UZ	12	GA7020	91	HM1812	79	HR3540C	75
DTW190RFJ	22	DUX60ZM4	13	GA9012C	91	HP1630K	70	HR4002	75
DTW190Z	22	DVC261ZX11	50	GA9020	91	HP1631K	70	HR4003C	75
DTW251RTJ	21	DVC265ZXU	49	GA9020K	91	HP1640	70	HR4013C	75
DTW251Z	21	DVC750LZX1	49	GA9020RF	91	HP1640K	70	HR4501C	76
DTW285RFJX	21	DVC860LZ	115	GA9020RFK	91	HP1641K1X	70	HR4511C	75
DTW285Z	21	DVC862LZ	115	GA9030X01	90	HP2050HJ	71	HR5202C	76
DTW450RTJ	21	DVC864LZX	115	GA9040R	89	HP2051HJ	71	HR5212C	76
DTW450Z	21	DVP180Z	31	GA9040RF01	89	HP2070J	70	HS0600	106
DUB182Z	32	DVR450RTE	32	GA9050R	91	HP2071J	70	HS301DSME	40
DUB183Z	35	DVR450Z	32	GA9060R	90	HP332DSAE	37	HS301DZ	40
DUB361Z	11	E		GA9062R	90	HP332DSME	37	HS6101J	104
DUB362Z	11	EG2250A	121	GA9063R	90	HP332DZ	37	HS6601	105
DUC122Z	33	EG2850A	121	GB602	96	HP333DSAE	37	HS6601J	105
DUC252PT2	12	EG4550A	121	GB602W	97	HP333DZ	37	HS7100	105
DUC254Z	33	EG5550A	121	GB801	97	HP457DWE	53	HS7101	105
DUC302Z	12	EG6050A	121	GD0601	95	HR140DSMJ	39	HS7601	105
DUC353Z	8	EK7301WS	121	GD0603	95	HR140DWYE1	39	HS7611J	105
DUC355PT2	8	EK7651H	121	GD0800C	96	HR140DZ	39	HW102	122
DUC355Z	8	EK8100	121	GD0801C	95	HR166DSMJ	39	HW111	122
DUH523Z	33	F		GD0810C	96	HR166DZ	39	HW1200	122
DUH551PT2	12	FS2300	66	GS5000	96	HR1840	71	HW1300	122
DUH551Z	12	FS2700	67	H		HR2300	71	HW132	122
DUH601PTE	11	FS4000	66	HG5030K	122	HR2470	72	HW151	122
DUH601Z	11	FS4300	66	HG6031VK	123	HR2470BX40	72	J	
DUH602RT	11	FS4300X2	66	HG6531CK	123	HR2470T	71	JN1601	86
DUH602Z	11	FS6300R	67	HK1820	79	HR2600	73	JN3201J	86
DUH651Z	12	G		HM0870C	76	HR2630	73	JR103DSAE	41
DUH751PTE	12	GA4530R	89	HM0871C	76	HR2630T	73	JR103DSME	41
DUH751Z	12	GA5021C	88	HM1101C	77	HR2630X7	73	JR103DZ	41
DUM604RF	34	GA5030R	89	HM1111C	77	HR2631F	72	JR105DSME	41
DUM604ZX	34	GA5030RSP4	89	HM1203C	77	HR2631FT	72	JR105DZ	41
DUP361PT2	12	GA5030RX1	89	HM1205C	77	HR2641	72	JR3050T	108

JR3060T	108	M2401	132	PW5000CH	92	TW0350	67	Sety náradia	
JR3070CT	108	M3600	133	R		TW060DSAE	38	DDF485RFJ + 632G12-3	126
JS1000	85	M3601	133	RP0900	112	TW060DZ	38		
JS1601	85	M4301	132	RP0910J	112	TW1000	68	DHP485RFJ + DTD171Z	126
JS1602	85	M4500K	133	RP1110CJ	112	TW140DSAEEX	38	DCL180Z + 195584-2 + 632B42-4	127
JS3201J	85	M4501K	132	RP1800FXJ	113	TW140DSMJ	38		
JV0600K	107	M5802	132	RP2300FCXJ	113	TW140DZ	38	DDF453RFE + DLC180Z	127
JV101DSME	41	M6002	130	RT0700C	111	U			
JV101DZ	41	M6600	130	RT0700CX2J	111	UB1103	116	DLX2126TJ1 + TR00000001	127
JV102DZ	40	M8103	130	S		UC3041A	120		
JV103DSMJ	40	M8700	130	SA5040C	92	UC3051AX1	120	HR5212C + DMR108	127
JV103DZ	40	M8701Z	130	SA7000C	91	UC3541A	120	LS1019L + RP1800FXJ	127
K		M9001	131	SG1251J	83	UC3551AX1	120		
KC100	113	M9203	132	SG150	84	UC4041A	120	DF331DSAE + CL108FDZ	127
KP0800	110	M9204	131	SG181	83	UC4051AX1	120		
KP0810	110	M9400	131	SK103PZ	123	UH201DZ	42	HR2470T + GA4530R	127
KP0810C	110	M9502R	131	SK104Z	123	UM600DWAEX	42		
KP312S	111	M9503R	131	SK312GDZ	123	UM600DZX	42	HR2630 + GA5030R	127
L		MAC610	118	SKR200Z	124	UR100DSAEEX	42	HR2630T + GA9060R	127
LB1200F	108	MEU029J	126	SP6000J	106	UR100DWAE	42	HS6601J + 197462-2 + 199141-8	127
LC1230N	84	MLS100	104	ST113DSAJ	41	UR100DZ	42		
LD030P	124	MLS100N	104	ST113DZ	41	UR100DZX	42		
LD050P	124	MLT100	104	T		UT1200	66	SG150 + VC4210L	128
LD080PI	124	MLT100N	104	TD0101F	63	UT1305	66	DBM230 + P-54190	128
LF1000	103	MP100DZ	47	TD021DSE	52	UT1400	65		
LH1040	103	MR052	48	TD022DSE	52	UT1401	65	KP0800 + 824892-1	128
LH1201FL	103	N		TD110DSAE	38	UT1600	65		
LS0714N	102	N1923B	110	TD110DSME	38	UT2204	66	MAC610 + AF505N + P-45973	128
LS0815FL	102	N5900B	106	TD110DZ	38	V			
LS0815FLN	102	P		TD111DSAE	38	VC2012L	116		
LS1018L	102	PC5000C	95	TD111DZ	38	VC2512L	116		
LS1018LN	102	PC5010C	95	TL064DSAJ	39	VC3011L	116		
LS1019L	102	PF0300	122	TL064DZ	39	VC3012L	116		
LS1040N	103	PF0410	122	TL065DSAJ	39	VC3012M	116		
LS1219L	102	PF0800	122	TL065DZ	39	VC3210LX1	115		
LW1400	84	PF1010	122	TM3010C	96	VC3211MX1	115		
LW1401	84	PJ7000J	111	TM3010CX5J	96	VC4210L	116		
M		PO6000C	92	TM30DWYE	40	VC4210M	116		
M1901	133	PT354DZ	41	TM30DZ	40				
M1902	133	PV7000C	92	TW0200	67				

Li-Ion akumulátory a nabíjačky

18V Lithium-ion		DC18RC	DC18RD Dvojnabíjačka Rýchlonabíjačka	DC18RE CXT&LXT Rýchlonabíjačka	DC18SF * Okrem BL1430A	DC18SD	DC18SE (Automotive)
6.0 Ah	 BL1860B	Fast Charging			1 až 2 akumulátory 130 min.	3 až 4 akumulátory 260 min.	130 min.
5.0 Ah	 BL1850B	Fast Charging			110 min.	220 min.	110 min.
4.0 Ah	 BL1840B	Fast Charging			90 min.	180 min.	90 min.
3.0 Ah	 BL1830B	Fast Charging			60 min.	120 min.	60 min.
2.0 Ah	 BL1820B	Fast Charging			45 min.	90 min.	45 min.
1.5 Ah	 BL1815N	Fast Charging			30 min.	60 min.	30 min.

12Vmax Lithium-ion		DC18RE CXT&LXT Rýchlonabíjačka	DC10SB	DC10WD	10.8V Lithium-ion	DC10WA
4.0 Ah	 BL1041B	Fast Charging			1.3 Ah	50 min.
2.0 Ah	 BL1021B	Fast Charging			7.2V Lithium-ion	DC10WA
1.5 Ah	 BL1016	Fast Charging			1.5 Ah	35 min.

18V Lithium-ion		DC18WA
1.5 Ah	 BL1815G Pre model: DF347D, HP347D, JV143D, ML187, TD126D, UH420D, UH480D, UH520D, UM165D, UR140D, DMR106	70 min.

Video bolo natočené v Japonsku,
modely a špecifikácie sa môžu
odlišovať podľa krajín.



18V X2 Lithium-ion

18V + 18V → 36V



18 V akumulátory Makita

B – s ukazovateľom kapacity akumulátora

1,5Ah
BL1815N



2,0Ah
BL1820B



3,0Ah
BL1830B



4,0Ah
BL1840B



5,0Ah
BL1850B



6,0Ah
BL1860B



Aku fúrik

DCU180Z

Li-ion



18V

BL MOTOR **XPT**
EXTREME PROTECTION TECHNOLOGY

Max. pracovný čas (min)	s BL1860B: 120
Nosnosť	130 kg
Rychlosť	Vpred. 1 / 2: 0 – 3,5 / 0 – 1,5 km/h
	Vzad. 0 – 1 km/h
Max. stúpanie	12°
Hmotnosť	39,3 – 44,8 kg

DCU180Z
799,90 €

DCU180Z + 199009-8
939,90 €

DCU180Z + 199008-0
899,90 €

Aku uhlová brúska

DGA900 230 mm

Li-ion



18V

BL MOTOR **ADT AFT** (BRAKE) **XPT**
EXTREME PROTECTION TECHNOLOGY

Priemer kotúča	230 mm
Vofnobežné otáčky / min ⁻¹	6.000
Úroveň akustického tlaku	88 dB(A)
Úroveň akustického výkonu	99 dB(A)
Rozmery	499x250x158 mm
Hmotnosť	5,2 – 8,0 kg

DGA900PT2
599,90 €

DGA900Z
289,90 €

Aku uhlová brúska

DGA901 230 mm

NOVINKA

Li-ion



18V

BL MOTOR **ADT AFT** (BRAKE) **XPT**
EXTREME PROTECTION TECHNOLOGY

Priemer kotúča	230 mm
Vofnobežné otáčky / min ⁻¹	6.000
Úroveň akustického tlaku	88 dB(A)
Úroveň akustického výkonu	99 dB(A)
Rozmery	499x250x158 mm
Hmotnosť	5,2 – 8,0 kg

DGA901T2U1
669,90 €

DGA901ZUX1
359,90 €

Aku reťazová píla

DUC353 350 mm

Li-ion



18V

BL MOTOR **XPT**
EXTREME PROTECTION TECHNOLOGY

Dĺžka lišty	350 mm
Delenie reťaze	3/8"
Šírka drážky	1,1 / 1,3 mm
Rychlosť reťaze	0 – 20 m/s
	(0 – 1.200 m/min) (0 – 3.940 FPM)
Nádrž na olej	200 mL
Úroveň akustického tlaku	87,7 dB(A)
Úroveň akustického výkonu	100,4 dB(A)
Rozmery	773x215x235 mm
Hmotnosť	4,6 – 5,5 kg

DUC353Z
339,90 €

Aku reťazová píla

DUC355 350 mm

NOVINKA

Li-ion

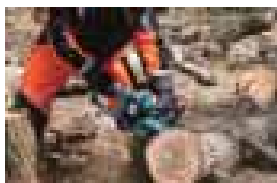

18V

BL MOTOR **XPT**
EXTREME PROTECTION TECHNOLOGY

Dĺžka lišty	350 mm
Delenie reťaze	3/8"
Šírka drážky	1,1 / 1,3 mm
Rychlosť reťaze	0 – 20 m/s
	(0 – 1.200 m/min) (0 – 3.940 FPM)
Nádrž na olej	200 mL
Úroveň akustického tlaku	87,7 dB(A)
Úroveň akustického výkonu	100,4 dB(A)
Rozmery	762x211x235 mm
Hmotnosť	4,7 – 5,4 kg

DUC355PT2
659,90 €

DUC355Z
369,90 €

Aku uhlová vrtačka

DDA460 13 mm

NOVINKA

Li-ion



18V



XPT **ADT** **BL**
EXTREME PROTECTION TECHNOLOGY MOTOR

Max. vrtací výkon	železo 13 mm, dřevo (vrták 118 mm / korunka 159 mm)
Voľnobežné otáčky	Max: 0 – 1 400 min ⁻¹ Min: 0 – 350 min ⁻¹
Max. uťahovací moment	Max: 136 Nm Min: 48 Nm
Vibrácie	vrtanie do železa 2,5 m/s ²
Úroveň akustického tlaku	85 dB (A)
Úroveň akustického výkonu	96 dB (A)
Rozmery	538×128×223 mm
Hmotnosť	5,7 – 6,4 kg

DDA460Z
549,90 €

Aku SDS Max kladivo

DHR400 40 mm

Li-ion



18V



AVT
ANTI VIBRATION TECHNOLOGY
AWS **BL** **XPT**
MOTOR EXTREME PROTECTION TECHNOLOGY

Energia príklepu	EPTA-Procedure 05/2009: 8,0 J
Max. vrtací výkon	Betón (s vrtákom): 40 mm Betón (s vrtácou korunkou): 105 mm
Počet úderov / min	1.450 – 2.900
Voľnobežné otáčky	250 – 500
Rozmery	473×120×285 mm
Hmotnosť	7,3 kg

DHR400PT4U
1 299,00 €

DHR400ZKU
799,90 €

Aku SDS Plus kladivo

DHR282 28 mm

NOVINKA

Li-ion



18V



AVT **AFT**
ANTI VIBRATION TECHNOLOGY
AWS **BL** **XPT** **ADT** **SOFT**
MOTOR EXTREME PROTECTION TECHNOLOGY NO LOAD

Energia príklepu	EPTA-Procedure 05/2009: 2,8 J
Max. vrtací výkon	Betón/železo/dřevo: 28 / 13 / 32 mm
Počet úderov / min ⁻¹	0 – 5000
Voľnobežné otáčky	0 – 980
Vibrácie	Vrtanie s príklepom do betónu: 9,0 m/s ² Vrtanie do železa: 2,5 m/s ²
Úroveň akustického tlaku	93 dB (A)
Úroveň akustického výkonu	104 dB (A)
Rozmery	373×134×232 mm
Hmotnosť	3,9 – 5,0 kg

DHR282T2JU
699,90 €

DHR282ZU
429,90 €

Aku SDS Plus kladivo

DHR280 28 mm

NOVINKA

Li-ion



18V



AVT **ADT**
ANTI VIBRATION TECHNOLOGY
BL **XPT** **SOFT**
MOTOR EXTREME PROTECTION TECHNOLOGY NO LOAD

Energia príklepu	EPTA-Procedure 05/2009: 2,8 J
Max. vrtací výkon	Betón/železo/dřevo: 28 / 13 / 32 mm
Počet úderov / min ⁻¹	0 – 5000
Voľnobežné otáčky	0 – 980
Vibrácie	Vrtanie s príklepom do betónu: 9,0 m/s ² Vrtanie do železa: 2,5 m/s ²
Úroveň akustického tlaku	93 dB (A)
Úroveň akustického výkonu	104 dB (A)
Rozmery	373×134×232 mm
Hmotnosť	3,9 – 4,9 kg

DHR280Z
329,90 €

Aku SDS Plus kladivo

DHR263 26 mm

Li-ion



18V



XPT
EXTREME PROTECTION TECHNOLOGY

Energia príklepu	EPTA-Procedure 05/2009: 2,5 J
Max. vrtací výkon	Betón/železo/dřevo: 26 / 13 / 32 mm
Počet úderov / min ⁻¹	0 – 5.000
Voľnobežné otáčky / min ⁻¹	0 – 1.250
Vibrácie	Vrtanie s príklepom do betónu: 15,5 m/s ² Vrtanie do železa: 5,0 m/s ²
Úroveň akustického tlaku	94 dB(A)
Úroveň akustického výkonu	105 dB(A)
Rozmery	374×116×232 mm
Hmotnosť	4,2 – 5,1 kg

DHR263PT2J
599,90 €

DHR263Z
249,90 €

Aku SDS Plus kladivo

DHR264 26 mm

Li-ion

Rýchloskľučovadlo



18V



Energia príklepu	EPTA-Procedure 05/2009: 2,5 J
Max. vrtací výkon	Betón/železo/drevo: 26 / 13 / 32 mm
Počet úderov / min ⁻¹	0 – 5.000
Vofnobežné otáčky / min ⁻¹	0 – 1.250
Vibrácie	Vŕtanie s príklepom do betónu: 14,5 m/s ² Vŕtanie do železa: 3,0 m/s ²
Úroveň akustického tlaku	94 dB(A)
Úroveň akustického výkonu	105 dB(A)
Rozmery	350x116x232 mm
Hmotnosť	4,1 – 5,1 kg

DHR264PT2J
599,90 €DHR264Z
299,90 €

Aku pokosová píla

DLS111 260 mm

Li-ion



18V

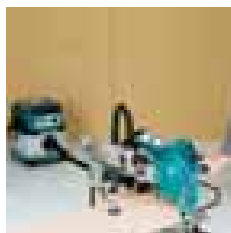

Priemer kotúča	260 mm
Max. uhol pokosu	60° L / 60° R
Max. uhol úkosu	48° L / 48° R
Max. rezný výkon	90°: 91x279 mm 90°: 68x310 mm
Vofnobežné otáčky / min ⁻¹	4.400
Úroveň akustického tlaku	92 dB(A)
Úroveň akustického výkonu	102 dB(A)
Vibrácie	2,5 m/s ²
Rozmery	805x644x660 mm
Hmotnosť	26,6 – 27,3 kg

DLS111ZU
999,90 €

Aku kotúčová píla

DHS710 190 mm

Li-ion



18V



Priemer kotúča	190 / 185 mm
Max rezný výkon	90°: 68,5 / 66 mm 45°: 49 / 47,5 mm 50°: 44 / 42,5 mm
Vofnobežné otáčky / min ⁻¹	4.800
Vibrácie	Rez do dreva: 2,5 m/s ²
Úroveň akustického tlaku	85 dB(A)
Úroveň akustického výkonu	96 dB(A)
Rozmery	356x217x298 mm
Hmotnosť	3,9 – 4,6 kg

DHS710PT2J
599,90 €DHS710Z
249,90 €

Aku ponorná píla

DSP601/DSP600 165 mm

Li-ion



18V



Priemer kotúča	165 mm
Max rezný výkon	90°: 56 mm 45°: 40 mm 48°: 38 mm
Vofnobežné otáčky / min ⁻¹	2.500 – 6.300
Vibrácie	2,5 m/s ²
Úroveň akustického tlaku	92 dB(A)
Úroveň akustického výkonu	103 dB(A)
Rozmery	346x241x272 mm
Hmotnosť	4,4 – 5,1 kg

DSP600ZJ
449,90 €DSP601ZJU
499,90 €

Aku rezač na železo

DLW140 355 mm

NOVINKA

Li-ion



18V

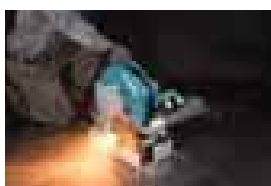

Priemer rezného kotúča	355 mm
Vŕtanie kotúča	25,4 mm
Vofnobežné otáčky	3 800
Max. výkon	1 300 W
Vibrácie	2,5 m/s ²
Úroveň akustického tlaku	103 dB(A)
Úroveň akustického výkonu	115 dB(A)
Rozmery	537x290x640 mm
Hmotnosť	17,2 – 17,8 kg

DLW140Z
389,90 €

Aku chvostová píla

DJR360

Li-ion



18V



Dĺžka kmitu	32 mm
Kmity / min	Max/min: 0 - 3.000 / 0 - 2.300
Max. rezný výkon	Rúra: 130 mm
	Drevo: 255 mm
Úroveň akustického tlaku	85 dB(A)
Úroveň akustického výkonu	96 dB(A)
Rozmery	449x116x243 mm
Hmotnosť	4,0 - 4,7 kg

DJR360PT2
649,90 €

DJR360Z
279,90 €

Aku fukár

DUB362

Li-ion



18V

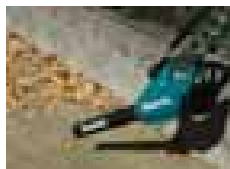

Max. prietok vzduchu	13,4 m³/min (473 CFM)
Max. rýchlosť vzduchu	54 m/s (120 MPH)
Voľnobežné otáčky / min⁻¹	11.400 - 21.500
Úroveň akustického tlaku	79,1 dB(A)
Úroveň akustického výkonu	93,5 dB(A)
Vibrácie	2,5 m/s²
Rozmery	830/880/930x205x295 mm
Hmotnosť	3,5 - 4,2 kg

DUB362Z
269,90 €

Aku fukár

DUB361

Li-ion



18V

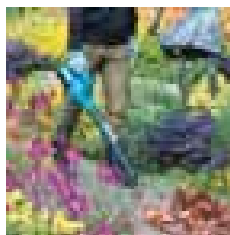

Max. prietok vzduchu	Max: 4,4 m³/min (155 CFM) Min: 2,6 m³/min (92 CFM)
Max. rýchlosť vzduchu	Max: 93 m/s (208 MPH) Min: 57 m/s (128 MPH)
Voľnobežné otáčky / min⁻¹	Max: 17.000 Min: 10.000
Úroveň akustického tlaku	82,3 dB(A)
Úroveň akustického výkonu	94,7 dB(A)
Vibrácie	2,5 m/s²
Rozmery	905x141x194 mm
Hmotnosť	3,1 - 3,2 kg

DUB361Z
189,90 €

Aku krovinoz

DUH601

Li-ion



18V

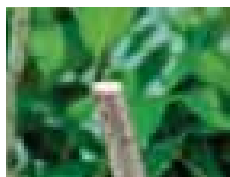

Dĺžka noža	600 mm
Max. rezný výkon	23,5 mm
Počet strihov/min	Max/priemer/min 0 - 4 400 / 0 - 3 600 / 0 - 2 000
Rozmery	1 121x192x225 mm
Hmotnosť	4,0 - 4,3 kg

DUH601PTE
559,90 €

DUH601Z
299,90 €

Aku krovinoz

DUH602

Li-ion



18V

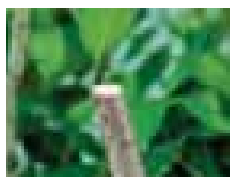

Dĺžka noža	600 mm
Max. rezný výkon	23,5 mm
Počet strihov/min	Max/priemer/min 0 - 4 400 / 0 - 3 600 / 0 - 2 000
Rozmery	1 121x192x225 mm
Hmotnosť	3,9 - 4,3 kg

DUH602RT
399,00 €

DUH602Z
269,90 €

Aku krovinořez

DUH751

Li-ion

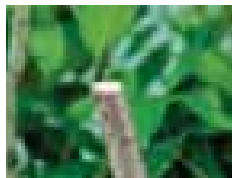

18V

BL
MOTOR

Dĺžka noža	750 mm
Max. rezný výkon	23,5 mm
Počet strihov/min	Max/priemer/min
	0 - 4 400 / 0 - 3 600 / 0 - 2 000
Rozmery	1 261x192x225 mm
Hmotnosť	4,1 - 4,5 kg

DUH751PTE
569,90 €DUH751Z
319,90 €

Aku plotostrih

DUH551/DUH651 550 mm / 650 mm

Li-ion



18V

XPT
EXTREME PROTECTION TECHNOLOGY

	DUH551	DUH651
Dĺžka noža	550 mm	650 mm
Voľnobežné otáčky / min ⁻¹	2.000 - 3.600	2.000 - 3.600
Rozstup nožov	36 mm	36 mm
Úroveň akustického tlaku	81,5 dB(A)	82 dB(A)
Úroveň akustického výkonu	91 dB(A)	91,1 dB(A)
Vibrácie	2,5 m/s ²	2,5 m/s ²
Rozmery	1.065x225x200 mm	1.135x225x200 mm
Hmotnosť	4,6 - 5,3 kg	4,7 - 5,5 kg

DUH551PT2
599,90 €DUH551Z
299,90 €DUH651Z
309,90 €

Aku píla

DUC252/DUC302 250 mm / 300 mm

Li-ion



18V

XPT
EXTREME PROTECTION TECHNOLOGY

	DUC252	DUC302
Dĺžka lišty	250 mm	300 mm
Delenie reťaze	3/8"	3/8"
Šírka drážky	1,3 mm	1,1 mm
Rychlosť reťaze	8,3 m/s	8,3 m/s
	(500 m/min) (1.650 FPM)	(500 m/min) (1.650 FPM)
Nádrž na olej	85 mL (2,9 US oz)	85 mL (2,9 US oz)
Úroveň akustického tlaku	84,4 dB(A)	84,4 dB(A)
Úroveň akustického výkonu	95,4 dB(A)	95,4 dB(A)
Vibrácie	Pri rezaní dreva: 4,7 m/s ²	Pri rezaní dreva: 6,3 m/s ²
Rozmery	545x234x198 mm	600x234x198 mm
Hmotnosť	4,1 - 4,7 kg	4,7 kg

DUC252PT2
399,90 €DUC302Z
289,90 €

Aku vyžinač

DUR365U

Li-ion



18V

BL MOTOR XPT
EXTREME PROTECTION TECHNOLOGY

Rezná šírka	Kovový žací nóz: 230 mm
	Žacia hlava: 350 mm
	Plastový žací nóz: 255 mm
Voľnobežné otáčky / min ⁻¹	Max/priemer/min: 6.500 / 5.300 / 3.500
Uchytenie na vretene	M10x1,25 LH
Úroveň akustického tlaku	Kovový nóz: 75 dB(A)
Úroveň akustického výkonu	Kovový nóz: 86 dB(A)
Úroveň akustického tlaku	Plastový nóz: 83 dB(A)
Úroveň akustického výkonu	Plastový nóz: 92,8 dB(A)
Úroveň akustického tlaku	Nylónová žacia hlava: 77 dB(A)
Úroveň akustického výkonu	Nylónová žacia hlava: 90 dB(A)
Vibrácie	Vľavo/vpravo: 2,5 / 2,5 m/s ²
Rozmery	1.754x610x460 mm
Hmotnosť	4,3 - 5,0 kg

DUR365UZ
299,90 €

Aku nožnice na vinič

DUP361 260 mm

Li-ion



18V

XPT
EXTREME PROTECTION TECHNOLOGY

Max výkon	200 W
Max. rezný výkon	Max. priemer: 33 mm
Úroveň akustického tlaku	70 dB(A)
Vibrácie	2,5 m/s ²
Rozmery	305x43x106 mm
Hmotnosť	0,8 kg

DUP361PT2
1 499,00 €DUP361Z
1 199,00 €



18V

BL MOTOR AFT XPT
EXTREME PROTECTION TECHNOLOGY



Odporúčané príslušenstvo k DUX60ZM4:



DUX60ZM4
339,90 €

Cena len za samotný vyžinač.
V cene nie je zahrnuté odporúčané príslušenstvo.

Voľnobežné otáčky	Max: 0 – 9.700
	Stredné: 0 – 8.200
	Min: 0 – 5.700
Rozmery	1.011×320×216 mm
Hmotnosť	4,1 – 8,7 kg

Aku kosačka

DLM380 380 mm

Li-ion



18V

XPT
EXTREME PROTECTION TECHNOLOGY



Šírka noža	380 mm
Výška kosenia	25 – 75 mm
Objem zberného koša	40 L
Voľnobežné otáčky / min ⁻¹	3.700
Pre udržiavané trávnaté plochy	S BL1850B do 500 m ²
Veľkosť kolies	Predné/zadné: 140 / 190 mm
Úroveň akustického tlaku	81 dB(A)
Úroveň akustického výkonu	93 dB(A)
Vibrácie	2,5 m/s ²
Rozmery	1.145×465×1.023 – 1.070 mm
Hmotnosť	14,5 kg

DLM380PT2
399,90 €

DLM380Z
229,90 €

Aku kosačka

DLM431 430 mm

Li-ion



18V

XPT
EXTREME PROTECTION TECHNOLOGY



Šírka noža	430 mm
Výška kosenia	20 – 75 mm
Objem zberného koša	50 L
Voľnobežné otáčky / min ⁻¹	3.600
Pre udržiavané trávnaté plochy	S BL1850B do 500 m ²
Veľkosť kolies	Predné/zadné: 140 / 160 mm
Úroveň akustického tlaku	80 dB(A)
Úroveň akustického výkonu	93 dB(A)
Vibrácie	2,5 m/s ²
Rozmery	1.450 – 1.490×460×950 – 1.020 mm
Hmotnosť	17,8 – 18,4 kg

DLM431PT2
499,90 €

DLM431Z
299,90 €

Aku kosačka

DLM460 460 mm

NOVINKA

Li-ion



18V

BL MOTOR XPT SOFT NO LOAD
EXTREME PROTECTION TECHNOLOGY



Šírka noža	460 mm
Výška kosenia	20 – 75 mm
Objem zberného koša	60 L
Voľnobežné otáčky / min ⁻¹	2.500 – 3.300
Pre udržiavané trávnaté plochy	800 – 1.600 m ²
Veľkosť kolies	Predné/zadné 180 / 205 mm
Úroveň akustického tlaku	79 dB (A)
Úroveň akustického výkonu	91 dB (A)
Vibrácie	2,5 m/s ²
Rozmery	1.319 – 1.518×532×879 – 1.138 mm
Hmotnosť	25,3 – 27,6 kg

DLM460PT2
599,90 €

DLM460Z
399,90 €

18V LITHIUM-ION



LXT



18V x2

270+
STROJOV

6.0Ah 5.0Ah 4.0Ah
3.0Ah 2.0Ah 1.5Ah

Rozšírte si svoj aku sortiment

Aku skrutkovač

DDF481 13 mm

Li-ion



18V



Max. vrtací výkon	Železo: 13 mm
	Drevo: 76 mm
Rozsah skľučovadla	1,5 – 13 mm
Voľnobežné otáčky / min ⁻¹	Max / Min: 0 – 2.100 / 0 – 550
Max. uťahovací moment	Tvrký / mäkký spoj: 115 / 60 N·m
Max. povoľovací moment	125 N·m
Vibrácie	Vrtanie do železa: 2,5 m/s ²
Úroveň akustického tlaku	73 dB(A)
Max. výkon	640 W
Rozmery	205×79×266 mm
Hmotnosť	2,7 – 3,0 kg

BL XPT
 MOTOR EXTREME PROTECTION TECHNOLOGY
DDF481RTJ
499,90 €DDF481Z
259,90 €

Aku skrutkovač

DDF458 13 mm

Li-ion



18V

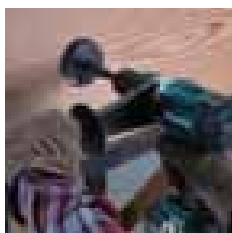

Max. vrtací výkon	Železo: 13 mm
	Drevo: 76 mm
Voľnobežné otáčky / min ⁻¹	Max: 0 – 2.000 Min: 0 – 400
Max. uťahovací moment	Tvrký / mäkký spoj: 91 / 58 N·m
Max. povoľovací moment	84 N·m
Rozmery	225×79×259 mm
Hmotnosť	2,1 – 2,5 kg

XPT
 EXTREME PROTECTION TECHNOLOGY
DDF458RF3J
449,90 €DDF458Z
149,90 €

DDF458RF3J – 3 ks akumulátorov

Aku skrutkovač

DDF482 13 mm

Li-ion



18V



Max. vrtací výkon	Železo / Drevo: 13 / 38 mm
Rozsah skľučovadla	1,5 – 13 mm
Voľnobežné otáčky / min ⁻¹	Max / Min: 0 – 1.900 / 0 – 600
Max. uťahovací moment	Tvrký / mäkký spoj: 62 / 36 N·m
Max. povoľovací moment	54 N·m
Vibrácie	Vrtanie do železa: 2,5 m/s ²
Úroveň akustického tlaku	75 dB(A)
Rozmery	185×79×249 mm
Hmotnosť	1,5 – 1,8 kg

XPT
 EXTREME PROTECTION TECHNOLOGY
DDF482RFEB
289,90 €DDF482RFJ
299,90 €DDF482Z
89,90 €

B – čierne prevedenie stroja

Aku skrutkovač

DDF484 13 mm

Li-ion



18V



Max. vrtací výkon	Železo / Drevo: 13 / 38 mm
Rozsah skľučovadla	1,5 – 13 mm
Voľnobežné otáčky / min ⁻¹	Max / Min: 0 – 2.000 / 0 – 500
Max. uťahovací moment	Tvrký / mäkký spoj: 54 / 30 N·m
Max. povoľovací moment	60 N·m
Vibrácie	Vrtanie do železa: 2,5 m/s ²
Úroveň akustického tlaku	76 dB(A)
Rozmery	172×79×261 mm
Hmotnosť	1,5 – 1,8 kg

BL XPT
 MOTOR EXTREME PROTECTION TECHNOLOGY
DDF484RFJ
349,90 €DDF484Z
159,90 €

Aku skrutkovač

DDF485 13 mm

NOVINKA

Li-ion



18V



Max. vrtací výkon	Železo / drevo 13 / 38 mm
Rozsah skľučovadla	1,5 – 13 mm
Voľnobežné otáčky / min ⁻¹	Max: 0 – 1 900 Min: 0 – 500
Max. uťahovací moment	Tvrďý / mäkký spoj 50 / 27 Nm
Max. povoľovací moment	50 Nm
Vibrácie	Vrtanie do železa: 2,5 m/s ²
Úroveň akustického tlaku	74 dB (A)
Hmotnosť	1,4 – 1,7 kg

BL MOTOR XPT
EXTREME PROTECTION TECHNOLOGY



DDF485RFJ
329,90 €

DDF485Z
119,90 €

Aku skrutkovač

DDF453 13 mm

Li-ion



18V



Max. vrtací výkon	Železo: 13 mm Drevo: 36 mm
Rozsah skľučovadla	1,5 – 13 mm
Voľnobežné otáčky / min ⁻¹	Max: 0 – 1.300 Min: 0 – 400
Max. uťahovací moment	Tvrďý / mäkký spoj: 42 / 27 N·m
Max. povoľovací moment	38 N·m
Rozmery	222×79×244 mm
Hmotnosť	1,7 – 2,0 kg

BL MOTOR XPT
EXTREME PROTECTION TECHNOLOGY



DDF453RFE
269,90 €

DDF453SFX1
299,90 €

DDF453SYE
229,90 €

X1 – extra sada príslušenstva

Aku skrutkovač

DDF483 13 mm

Li-ion



18V



Max. vrtací výkon	Železo / Drevo: 13 / 36 mm
Rozsah skľučovadla	1,5 – 13 mm
Voľnobežné otáčky / min ⁻¹	Max / Min: 0 – 1.700 / 0 – 500
Max. uťahovací moment	Tvrďý / mäkký spoj: 40 / 23 N·m
Max. povoľovací moment	40 N·m
Vibrácie	Vrtanie do železa: 2,5 m/s ²
Úroveň akustického tlaku	77 dB(A)
Rozmery	162×79×247 mm
Hmotnosť	1,2 – 1,6 kg

BL MOTOR XPT
EXTREME PROTECTION TECHNOLOGY



DDF483RFJ
339,90 €

DDF483RTJ
419,90 €

DDF483Z
129,90 €

Aku skrutkovač

DDF083 13 mm

Li-ion



18V



Max. vrtací výkon	Železo / Drevo: 13 / 36 mm
Upínanie	1/4"
Voľnobežné otáčky / min ⁻¹	Max / Min: 0 – 1.700 / 0 – 500
Max. uťahovací moment	Tvrďý / mäkký spoj: 40 / 23 N·m
Max. povoľovací moment	40 N·m
Vibrácie	Vrtanie do železa: 2,5 m/s ²
Úroveň akustického tlaku	77 dB(A)
Rozmery	124×79×247 mm
Hmotnosť	1,1 – 1,4 kg

BL MOTOR XPT
EXTREME PROTECTION TECHNOLOGY



DDF083RFJ
299,90 €

DDF083Z
129,90 €

Aku skrutkovač s príklepom

DHP481 13 mm

Li-ion



18V



Max. vrtací výkon	Železo: 13 mm Drevo: 76 mm Murivo: 16 mm
Rozsah skľučovadla	1,5 – 13 mm
Počet úderov za minútu	Max / Min: 0 – 31.500 / 0 – 8.250
Voľnobežné otáčky / min ⁻¹	Max / Min: 0 – 2.100 / 0 – 550
Max. uťahovací moment	Tvrďý / mäkký spoj: 115 / 60 N·m
Max. povoľovací moment	125 N·m
Vibrácie	Vrtanie s príklepom do betónu: 6,5 m/s ² Vrtanie do železa: 2,5 m/s ²
Úroveň akustického tlaku	85 dB(A)
Úroveň akustického výkonu	96 dB(A)
Max. výkon	640 W
Rozmery	205×79×249 mm
Hmotnosť	2,7 – 3,0 kg

BL MOTOR XPT
EXTREME PROTECTION TECHNOLOGY



DHP481RTJ
549,90 €

DHP481Z
259,90 €

Aku skrutkovač s príklepom

DHP458 13 mm

Li-ion



18V



Max. vrtací výkon	Železo: 13 mm
	Drevo: 76 mm
	Murivo: 16 mm
Vofnobežné otáčky / min ⁻¹	Max: 0 – 2.000
	Min: 0 – 400
Počet úderov za minútu	Max: 0 – 30.000
	Min: 0 – 6.000
Max. uťahovací moment	Tvrký / mäkký spoj: 91 / 58 N-m
Max. povoľovací moment	84 N-m
Rozmery	225x79x259 mm
Hmotnosť	2,2 – 2,6 kg

DHP458RTJ
449,90 €DHP458Z
159,90 €XPT
EXTREME PROTECTION TECHNOLOGY

Aku skrutkovač s príklepom

DHP482 13 mm

Li-ion



18V

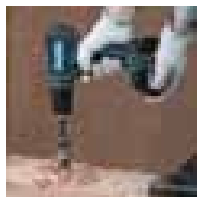

Max. vrtací výkon	Železo / Drevo / Murivo: 13 / 38 / 13 mm
Rozsah skľučovadla	1,5 – 13 mm
Počet úderov za minútu	Max / Min: 0 – 28.500 / 0 – 9.000
Vofnobežné otáčky / min ⁻¹	Max / Min: 0 – 1.900 / 0 – 600
Max. uťahovací moment	Tvrký / mäkký spoj: 62 / 36 N-m
Vibrácie	Vŕtanie s príklepom do betónu: 6,0 m/s ²
Rozmery	198x79x249 mm
Hmotnosť	1,5 – 1,8 kg

DHP482RFJ
299,90 €DHP482Z
99,90 €XPT
EXTREME PROTECTION TECHNOLOGY

Aku skrutkovač s príklepom

DHP484 13 mm

Li-ion



18V

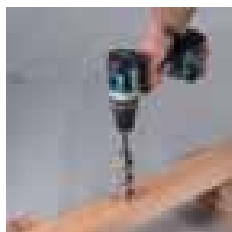

Max. vrtací výkon	Železo / Drevo / Murivo: 13 / 38 / 13 mm
Rozsah skľučovadla	1,5 – 13 mm
Počet úderov za minútu	Max / Min: 0 – 30.000 / 0 – 7.500
Vofnobežné otáčky / min ⁻¹	Max / Min: 0 – 2.000 / 0 – 500
Max. uťahovací moment	Tvrký / mäkký spoj: 54 / 30 N-m
Max. povoľovací moment	60 N-m
Vibrácie	Vŕtanie s príklepom do betónu: 8,0 m/s ²
	Vŕtanie do železa: 2,5 m/s ²
Úroveň akustického tlaku	88 dB(A)
Úroveň akustického výkonu	99 dB(A)
Rozmery	182x79x261 mm
Hmotnosť	1,6 – 1,9 kg

DHP484RFJ
369,90 €DHP484Z
159,90 €BL MOTOR XPT
EXTREME PROTECTION TECHNOLOGY

Aku skrutkovač s príklepom

DHP485 13 mm

NOVINKA

Li-ion



18V



Max. vrtací výkon	Železo / drevo / murivo 13 / 38 / 13 mm
Rozsah skľučovadla	1,5 – 13 mm
Počet úderov za minútu	Max/min 0 – 28 500 / 0 – 7 500
Vofnobežné otáčky / min ⁻¹	Max: 0 – 1 900
	Min: 0 – 500
Max. uťahovací moment	Tvrký / mäkký spoj 50 / 27 Nm
Max. povoľovací moment	50 Nm
Vibrácie	Vŕtanie do betónu: 8,0 m/s ²
Úroveň akustického tlaku	82 dB (A)
Úroveň akustického výkonu	93 dB (A)
Hmotnosť	1,5 – 1,8 kg

DHP485RFJ
339,90 €DHP485Z
129,90 €BL MOTOR XPT
EXTREME PROTECTION TECHNOLOGY

Aku skrutkovač s príklepom

DHP453 13 mm

Li-ion



18V



Max. vrtací výkon	Železo: 13 mm
	Drevo: 36 mm
	Murivo: 13 mm
Počet úderov za minútu	Max: 0 – 19.500
	Min: 0 – 6.000
Vofnobežné otáčky / min ⁻¹	Max: 0 – 1.300
	Min: 0 – 400
Max. uťahovací moment	Tvrký / mäkký spoj: 42 / 27 N-m
Max. povoľovací moment	38 N-m
Rozmery	240x79x244 mm
Hmotnosť	1,7 – 2,0 kg

DHP453RFE
279,90 €DHP453SYE
219,90 €

Aku skrutkovač s príklepom

DHP483 13 mm

Li-ion



18V



BL MOTOR XPT
EXTREME PROTECTION TECHNOLOGY

Max. vrtací výkon	Železo / Drevo / Murivo: 13 / 36 / 13 mm
Rozsah skľučovadla	1,5 – 13 mm
Počet úderov za minútu	Max / Min: 0 – 25.500 / 0 – 7.500
Voľnobežné otáčky / min ⁻¹	Max / Min: 0 – 1.700 / 0 – 500
Max. uťahovací moment	Tvrký / mäkký spoj: 40 / 23 N·m
Max. povoľovací moment	40 N·m
Vibrácie	Vŕtanie s príklepom do betónu: 10,0 m/s ²
	Vŕtanie do železa: 2,5 m/s ²
Úroveň akustického tlaku	83 dB(A)
Úroveň akustického výkonu	94 dB(A)
Rozmery	176×79×247 mm
Hmotnosť	1,3 – 1,6 kg

DHP483RFJ
359,90 €

DHP483Z
139,90 €

Aku rázový skrutkovač

DTD171

NOVINKA

Li-ion



18V



BL MOTOR XPT
EXTREME PROTECTION TECHNOLOGY

Max. vrtací výkon	Skrutka so šesťhrannou hlavou: M4 – M8
	Skrutka štandardná: M5 – M16
	Skrutka vysokopevnostná: M5 – M14
Upínanie	¼"
Voľnobežné otáčky min ⁻¹	Max / Hard / Med / Soft / Wood / Bolt / T (1) / T (2) mód : 0 – 3.600 / 3.200 / 2.100 / 1.100 / 1.800 / 3.600 / 2.900 / 3.600
Počet úderov za minútu	Max / Hard / Med / Soft / Wood / Bolt / T (2) mód : 0 – 3.800 / 3.600 / 2.600 / 1.100 / 3.800 / 3.800 / 2.600
Max. uťahovací moment	180 Nm
Vibrácie	13,5 m/s ²
Úroveň akustického tlaku	97 dB (A)
Úroveň akustického výkonu	108 dB (A)
Rozmery	116×79×236 mm
Hmotnosť	1,2 – 1,6 kg

DTD171RTJ
469,90 €

DTD171Z
189,90 €

Aku rázový skrutkovač

DTD170

Li-ion



18V



BL MOTOR XPT
EXTREME PROTECTION TECHNOLOGY

Max. vrtací výkon	Skrutka so šesťhrannou hlavou: M4 – M8
	Skrutka štandardná: M5 – M16
	Skrutka vysokopevnostná: M5 – M14
Upínanie	1/4"
Voľnobežné otáčky / min ⁻¹	Max / Tvrký / Priemer / Mäkký / Tmode 0 – 3.600 / 3.200 / 2.100 / 1.100 / 3.600
Počet úderov za minútu	Max / Tvrký / Priemer / Mäkký / Tmode 0 – 3.800 / 3.600 / 2.600 / 1.100 / 2.600
Max. uťahovací moment	175 N·m
Vibrácie	12,5 m/s ²
Úroveň akustického tlaku	98 dB(A)
Úroveň akustického výkonu	109 dB(A)
Rozmery	117×79×236 mm
Hmotnosť	1,2 – 1,5 kg

DTD170RTJ
499,90 €

DTD170Z
219,90 €

Aku rázový skrutkovač

DTD154

Li-ion



18V



BL MOTOR XPT
EXTREME PROTECTION TECHNOLOGY

Max. vrtací výkon	Skrutka so šesťhrannou hlavou: M4 – M8
	Skrutka štandardná: M5 – M16
	Skrutka vysokopevnostná: M5 – M14
Upínanie	1/4"
Voľnobežné otáčky / min ⁻¹	Max / Tvrký / Priemer / Mäkký / Tmode 0 – 3.600 / 0 – 2.100 / 0 – 1.100
	Max / Tvrký / Priemer / Mäkký / Tmode
Počet úderov za minútu	0 – 3.800 / 0 – 2.600 / 0 – 1.100
Max. uťahovací moment	175 N·m
Vibrácie	12,5 m/s ²
Úroveň akustického tlaku	96 dB(A)
Úroveň akustického výkonu	107 dB(A)
Rozmery	117×79×236 mm
Hmotnosť	1,3 – 1,6 kg

DTD154RTJ
459,90 €

DTD154Z
179,90 €

Aku rázový skrutkovač

DTD153

Li-ion



18V



BL MOTOR XPT
EXTREME PROTECTION TECHNOLOGY

Max. vrtací výkon	Skrutka so šesťhrannou hlavou: M4 – M8
	Skrutka štandardná: M5 – M16
	Skrutka vysokopevnostná: M5 – M14
Upínanie	1/4"
Voľnobežné otáčky / min ⁻¹	0 – 3.400
Počet úderov za minútu	0 – 3.600
Max. uťahovací moment	170 N·m
Vibrácie	13,0 m/s ²
Úroveň akustického tlaku	96 dB(A)
Úroveň akustického výkonu	107 dB(A)
Rozmery	126×79×238 mm
Hmotnosť	1,3 – 1,6 kg

DTD153RFJ
369,90 €

DTD153Z
139,90 €

Aku rázový skrutkovač

DTD152

Li-ion



18V



Max. vrtací výkon	Skrutka so šesťhrannou hlavou: M4 – M8 Skrutka štandardná: M5 – M16 Skrutka vysokopevnosťná: M5 – M12
Upínanie	1/4"
Voľnobežné otáčky / min ⁻¹	0 – 2.900
Počet úderov za minútu	0 – 3.500
Max. ťahovací moment	165 N·m
Vibrácie	10,5 m/s ²
Úroveň akustického tlaku	93 dB(A)
Úroveň akustického výkonu	104 dB(A)
Rozmery	137×79×238 mm
Hmotnosť	1,3 – 1,6 kg

DTD152RTJ
359,90 €DTD152Z
89,90 €XPT
EXTREME PROTECTION TECHNOLOGY

Aku rázový skrutkovač

DTD155

Li-ion



18V

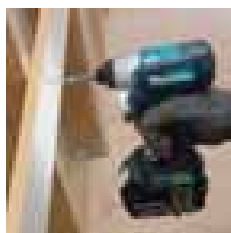

Max. vrtací výkon	Skrutka so šesťhrannou hlavou: M4 – M8 mm Skrutka štandardná: M5 – M14 Skrutka vysokopevnosťná: M5 – M12
Upínanie	1/4"
Voľnobežné otáčky / min ⁻¹	Tvrдый / mäkký spoj: 0 – 3.000 / 0 – 1.300
Počet úderov za minútu	Tvrдый / mäkký spoj: 0 – 3.900 / 0 – 1.600
Max. ťahovací moment	140 N·m
Úroveň akustického tlaku	94 dB(A)
Úroveň akustického výkonu	105 dB(A)
Rozmery	135×79×232 mm
Hmotnosť	1,2 – 1,5 kg

DTD155Z
129,90 €BL MOTOR XPT
EXTREME PROTECTION TECHNOLOGY

Aku olejovo pulzný skrutkovač

DTS141

Li-ion



18V



Max. vrtací výkon	Skrutka so šesťhrannou hlavou: M4 – M8 Skrutka štandardná: M5 – M8 Skrutka vysokopevnosťná: M5 – M6
Voľnobežné otáčky / min ⁻¹	Max.: 0 – 3.200 Priemer: 0 – 2.000 Min.: 0 – 1.200
Počet úderov za minútu	Tvrдый spoj: 0 – 2.700 Stredný spoj: 0 – 2.200 Mäkký spoj: 0 – 1.400
Max. ťahovací moment	40 N·m
Hlučnosť	77 dB(A)
Rozmery	136×79×240 mm
Hmotnosť	1,3 – 1,6 kg

DTS141Z
369,90 €BL MOTOR XPT
EXTREME PROTECTION TECHNOLOGY

Aku rázový ťahovač

DTW1001 3/4"

Li-ion



18V



Max. ťahovací výkon	Skrutka štandardná: M12 – M30 Skrutka vysokopevnosťná: M10 – M24
Upínanie	3/4"
Voľnobežné otáčky / min ⁻¹	Tvrдый / stredný / mäkký spoj: 0 – 1.800 / 0 – 1.000 / 0 – 900
Počet úderov za minútu	Tvrдый / stredný / mäkký spoj: 0 – 2.200 / 0 – 2.000 / 0 – 1.800
Max. ťahovací moment	1.050 N·m
Vibrácie	15,5 m/s ²
Úroveň akustického tlaku	98 dB(A)
Úroveň akustického výkonu	109 dB(A)
Rozmery	229×91×289 mm
Hmotnosť	3,4 – 3,7 kg

DTW1001RTJ
699,90 €DTW1001Z
399,90 €

BL MOTOR



Aku rázový uťahovač

DTW1002 1/2"

Li-ion



18V



Max. uťahovací výkon	Skrutka štandardná: M12 – M30 Skrutka vysokopevnostná: M10 – M24
Upínanie	1/2"
Voľnobežné otáčky / min ⁻¹	Tvrký / stredný / mäkký spoj: 0 – 1.800 / 0 – 1.000 / 0 – 900
Počet úderov za minútu	Tvrký / stredný / mäkký spoj: 0 – 2.200 / 0 – 2.000 / 0 – 1.800
Max. uťahovací moment	1.000 N·m
Vibrácie	18,0 m/s ²
Úroveň akustického tlaku	97 dB(A)
Úroveň akustického výkonu	108 dB(A)
Rozmery	229×91×289 mm
Hmotnosť	3,3 – 3,6 kg

DTW1002RTJ
669,90 €

DTW1002Z
399,90 €

BL
MOTOR

Aku rázový uťahovač

DTW450 1/2"

Li-ion



18V

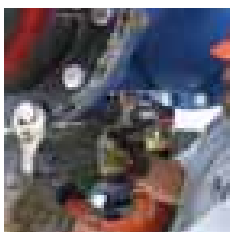

Max. uťahovací výkon	Skrutka štandardná: M12 – M22 Skrutka vysokopevnostná: M12 – M16
Upínanie	1/2"
Voľnobežné otáčky / min ⁻¹	1.600
Počet úderov za minútu	2.200
Max. uťahovací moment	440 N·m
Vibrácie	19 m/s ²
Úroveň akustického tlaku	94 dB(A)
Úroveň akustického výkonu	105 dB(A)
Rozmery	266×82×290mm
Hmotnosť	3,1 – 3,4 kg

DTW450RTJ
569,90 €

DTW450Z
259,90 €

Aku rázový uťahovač

DTW285 1/2"

Li-ion



18V



Max. uťahovací výkon	Skrutka štandardná: M10 – M20 Skrutka vysokopevnostná: M10 – M16
Upínanie	1/2"
Voľnobežné otáčky / min ⁻¹	Tvrký / stredný / mäkký spoj: 0 – 2.800 / 0 – 2.100 / 0 – 1.600
Počet úderov za minútu	Tvrký / stredný / mäkký spoj: 0 – 3.500 / 0 – 2.600 / 0 – 1.800
Max. uťahovací moment	280 N·m
Vibrácie	11,5 m/s ²
Úroveň akustického tlaku	96 dB(A)
Úroveň akustického výkonu	107 dB(A)
Rozmery	147×79×249 mm
Hmotnosť	1,5 – 1,8 kg

DTW285Z
249,90 €

DTW285RFJX
469,90 €

X – 9 ks sada nástrčkových kľúčov

BL XPT
MOTOR EXTREME PROTECTION TECHNOLOGY

Aku rázový uťahovač

DTW251 1/2"

Li-ion



18V



Max. uťahovací výkon	Skrutka štandardná: M10 – M16 Skrutka vysokopevnostná: M10 – M14
Upínanie	1/2"
Voľnobežné otáčky / min ⁻¹	0 – 2.100
Počet úderov za minútu	0 – 3.200
Max. uťahovací moment	230 N·m
Vibrácie	11,0 m/s ²
Úroveň akustického tlaku	94 dB(A)
Úroveň akustického výkonu	105 dB(A)
Rozmery	165×79×234 mm
Hmotnosť	1,5 – 1,8 kg

DTW251RTJ
469,90 €

DTW251Z
159,90 €

Aku rázový uťahovač

DTW181 1/2"

NOVINKA

Li-ion



18V



Max. uťahovací výkon	Skrutka štandardná: M8 – M16 Skrutka vysokopevnostná: M6 – M12
Upínanie	1/2"
Voľnobežné otáčky / min ⁻¹	0 – 2.400
Počet úderov za minútu	0 – 3.600
Max. uťahovací moment	180 Nm
Hmotnosť	1,2 – 1,5 kg

DTW181RTJ
399,90 €

DTW181Z
139,90 €

BL XPT
MOTOR EXTREME PROTECTION TECHNOLOGY

Aku rázový uťahovač

DTW180 3/8"

Li-ion



18V



Max. uťahovací výkon	Skrutka štandardná: M8 – M16 Skrutka vysokopevnosťná: M6 – M12
Upínanie	3/8"
Voľnoběžné otáčky / min ⁻¹	Tvrдый / mäkký spoj: 0 – 2 400 / 0 – 1 300
Počet úderov za minútu	Tvrдый / mäkký spoj: 0 – 3 600 / 0 – 2 000
Max. uťahovací moment	180 N·m
Rozmery	s BL1815N / BL1820B: 144×79×218 mm s BL1830B / BL1840B / BL1850B / BL1860B: 144×79×235 mm
Hmotnosť	1,2 kg

DTW180RFJ
329,90 €DTW180Z
119,90 €BL XPT
MOTOR EXTREME PROTECTION TECHNOLOGY

Aku rázový uťahovač

DTW190 1/2"

Li-ion



18V



Max. uťahovací výkon	Skrutka štandardná: M8 – M16 Skrutka vysokopevnosťná: M8 – M12
Upínanie	1/2"
Voľnoběžné otáčky / min ⁻¹	0 – 2 300
Počet úderov za minútu	0 – 3 000
Max. uťahovací moment	190 N·m
Vibrácie	8,5 m/s ²
Úroveň akustického tlaku	94 dB(A)
Úroveň akustického výkonu	105 dB(A)
Rozmery	176 mm
Hmotnosť	1,4 – 1,8 kg

DTW190JX3
299,90 €DTW190RFJ
299,90 €DTW190Z
79,90 €

X3 – 9 ks sada nástrčkových kľúčov

Aku viazač armatúr

DTR180

NOVINKA

Li-ion



18V

14.4V



Max. hrúbka viazacieho drótu	0,8 m
Max. hrúbka armatúr	D10×D10 (D13x2)×(D13x2)
Vibrácie	2,5 m/s ²
Úroveň akustického tlaku	78 dB (A)
Hmotnosť	2,3 – 2,6 kg

DTR180ZJ
999,90 €BL XPT
MOTOR EXTREME PROTECTION TECHNOLOGY

Aku uhlová vrtáčka

DDA351 / DDA350 10 mm

Li-ion



18V

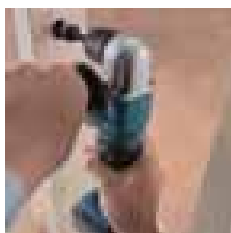

Max. vrtací výkon	Železo: 10 mm Drevo: 25 mm
Voľnoběžné otáčky / min ⁻¹	0 – 1 800
Rozmery	DDA351: 326×79×115 mm DDA350: 314×79×115 mm
Hmotnosť	DDA351: 1,6 – 1,9 kg DDA350: 1,5 – 1,8 kg

DDA351Z
179,90 €DDA350Z
179,90 €

Aku uhlový rázový skrutkovač

DTL063 3/8"

Li-ion



18V



Max. uťahovací výkon	Skrutka štandardná: M4 – M12 Skrutka vysokopevnosťná: M4 – M8
Upínanie	3/8"
Voľnoběžné otáčky / min ⁻¹	0 – 2 000
Počet úderov za minútu	0 – 3 000
Max. uťahovací moment	60 N·m
Vibrácie	16,5 m/s ²
Úroveň akustického tlaku	88 dB(A)
Úroveň akustického výkonu	99 dB(A)
Rozmery	387×78×116 mm
Hmotnosť	1,4 – 2,0 kg

DTL063RTJ
589,90 €

Aku skrutkovač

DFS452

Li-ion



18V



BL XPT
MOTOR EXTREME PROTECTION TECHNOLOGY

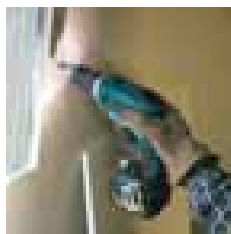

Max. vrtací výkon	Samozávrtné skrutky: 6 mm
	Skruty na sadrokartón: 5 mm
Upínanie	1/4"
Voľnobežné otáčky / min ⁻¹	0 – 4 000
Vibrácie	2,5 m/s ²
Úroveň akustického tlaku	72 dB(A)
Rozmery	251×79×259 mm
Hmotnosť	1,5 – 1,8 kg

DFS452Z
229,90 €

Aku skrutkovač

DFS251

Li-ion



18V



BL
MOTOR

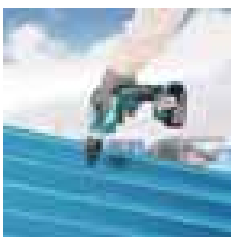

Max. vrtací výkon	Samozávrtné skrutky: 6 mm
	Skruty na sadrokartón: 5 mm
Upínanie	1/4"
Voľnobežné otáčky / min ⁻¹	0 – 2 500
Vibrácie	2,5 m/s ²
Úroveň akustického tlaku	72 dB(A)
Rozmery	237×79×259 mm
Hmotnosť	1,5 – 1,8 kg

DFS251RTJ
459,90 €

DFS251Z
189,90 €

Aku skrutkovač

DFR550

Li-ion



18V



Veľkosť skrutiek na páse	4×25 – 55 mm
Upínanie	1/4"
Voľnobežné otáčky / min ⁻¹	4 000
Vibrácie	2,5 m/s ²
Úroveň akustického tlaku	78 dB(A)
Rozmery	424×80×238 mm
Hmotnosť	2,1 – 3,1 kg

DFR550RFE
569,90 €

DFR550Z
269,90 €

Aku SDS Plus kladivo

DHR243 1/2" (12,7 mm)

Li-ion

Rýchlosklučovadlo



DHR243

18V



DHR243RTJW

BL XPT
MOTOR EXTREME PROTECTION TECHNOLOGY



Energia príklepu	2 J
Max. vrtací výkon	Betón: 24 mm
	Železo: 13 mm
	Drevo: 27 mm
Počet úderov za minútu	0 – 4 700
Voľnobežné otáčky / min ⁻¹	0 – 950
Úroveň akustického tlaku	89 dB(A)
Úroveň akustického výkonu	100 dB(A)
Vibrácie	Vŕtanie s príklepom do betónu: 13 m/s ²
	Sekanie: 11 m/s ²
	Vŕtanie: 2,5 m/s ²
Rozmery	353×85×213 mm
Hmotnosť	3,2 – 3,7 kg

DHR243RTJW
669,90 €

DHR243Z
299,90 €

W – s odsávacím zariadením

Aku SDS Plus kladivo

DHR241 20 mm

Li-ion



18V



Energia príklepu	1,9 J
Max. vrtací výkon	Betón: 20 mm
	Železo: 13 mm
	Drevo: 26 mm
Počet úderov / min ⁻¹	0 – 4 000
Voľnobežné otáčky / min ⁻¹	0 – 1 100
Úroveň akustického tlaku	86 dB(A)
Úroveň akustického výkonu	97 dB(A)
Vibrácie	Vŕtanie s príklepom do betónu: 12,5 m/s ²
Rozmery	417×84×219 mm
Hmotnosť	3,2 – 4,0 kg

DHR241RTJ
399,90 €

DHR241Z
159,90 €

Aku SDS Plus kladivo

DHR202 20 mm

Li-ion



18V



Max. vrtací výkon	Betón: 20 mm
	Železo: 13 mm
	Drevo: 26 mm
Počet úderov / min ⁻¹	0 – 4.000
Voľnobežné otáčky / min ⁻¹	0 – 1.100
Rozmery	358×84×259 mm
Hmotnosť	3,2 – 4,0 kg

DHR202RTJ
449,90 €DHR202Z
169,90 €

Aku SDS Plus kladivo

DHR171 17 mm

Li-ion



18V



Energia priklepiu	EPTA-Procedure 05/2009: 1,2 J
Max. vrtací výkon	Betón: 17 mm
	Železo: 10 mm
	Drevo: 13 mm
Počet úderov / min ⁻¹	0 – 4.800
Voľnobežné otáčky / min ⁻¹	0 – 680
Vibrácie	Vrtanie s priklepom do betónu: 9,0 m/s ²
	Vrtanie do železa: 2,5 m/s ²
Úroveň akustického tlaku	86 dB(A)
Úroveň akustického výkonu	97 dB(A)
Rozmery	s BL1815N / BL1820B: 273×86×194 mm
	s BL1830B / BL1840B / BL1850B / BL1860B: 273×86×211 mm
Hmotnosť	2,1 – 2,8 kg

DHR171RTJ
399,90 €DHR171Z
169,90 €

Aku rezač roxorov / závitových tyčí

DSC102

Li-ion



18V

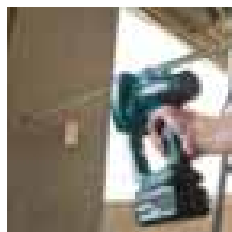

Max. rezný výkon	Železo: M6 – M10 mm
Rozmery	199×103×308 mm
Hmotnosť	2,9 – 3,3 kg

DSC102Z
599,90 €

Aku píla na železo

DCS552

NOVINKA

Li-ion



18V

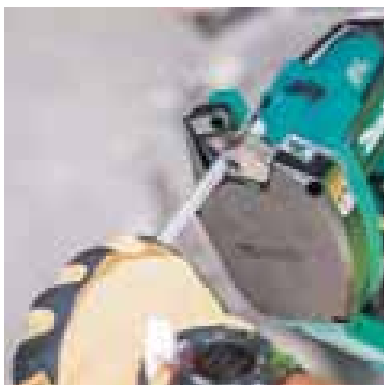

Priemer kotúča	136 mm
Max. rezný výkon	90°: 50,5 mm
Voľnobežné otáčky / min ⁻¹	3 600
Vibrácie	2,5 m/s ²
Úroveň akustického tlaku	102 dB (A)
Úroveň akustického výkonu	113 dB (A)
Rozmery	348×196×203 mm
Hmotnosť	2,4 – 2,7 kg

DCS552RTJ
449,90 €DCS552Z
189,90 €

Aku píla na železo

DCS553

NOVINKA

Li-ion



18V



Priemer kotúča	150 mm
Max. rezný výkon	90°: 57,5 mm
Voľnobežné otáčky / min ⁻¹	4 200
Vibrácie	2,5 m/s ²
Úroveň akustického tlaku	103 dB (A)
Úroveň akustického výkonu	114 dB (A)
Rozmery	267×186×250 mm
Hmotnosť	2,8 – 3,1 kg

BL ADT XPT
MOTOR
EXTREME PROTECTION TECHNOLOGY

DCS553RTJ
569,90 €

DCS553Z
299,90 €

Aku píla na železo

DCS551 150 mm

Li-ion



18V



Priemer kotúča	150 mm
Max. rezný výkon	90°: 57,5 mm
Voľnobežné otáčky / min ⁻¹	3.900
Vibrácie	2,5 m/s ²
Úroveň akustického tlaku	78 dB(A)
Rozmery	332×158×231 mm
Hmotnosť	2,5 – 2,8 kg

BL XPT
MOTOR
EXTREME PROTECTION TECHNOLOGY

DCS551Z
299,90 €

Aku rezač roxorov

DSC250 / DSC251

Li-ion



18V



Priemer kotúča	110 mm
Max. rezný výkon	Dia.: 10 – 25 mm
Voľnobežné otáčky / min ⁻¹	2.200
Vibrácie	Rezanie železa: 2,5 m/s ²
Úroveň akustického tlaku	78 dB(A)
Rozmery	471×137×139 mm
Hmotnosť	3,9 – 4,0 kg

BL ADT
MOTOR

DSC250RT
1 299,00 €

DSC250ZK
1 199,00 €

DSC251RT
1 399,00 €

Aku prestrihovač

DJS130 1,3 mm

Li-ion



18V



Max. výkon	Železo do 400 N/mm ² : 1,3 mm
	Železo do 600 N/mm ² : 1,0 mm
Voľnobežné otáčky / min ⁻¹	2.800
Rozmery	350×80×193 mm
Hmotnosť	2,3 – 2,6 kg

DJS130RFE
549,90 €

Aku prestrihovač

DJS101 1,0 mm

Li-ion



18V



Max. výkon	Železo do 400 N/mm ² : 1,0 mm
	Železo do 600 N/mm ² : 0,7 mm
	Hliník do 200 N/mm ² : 2,5 mm
Počet strihov za minútu	4.300
Rozmery	364×78×118 mm
Hmotnosť	1,8 – 2,2 kg

DJS101RFJ
589,90 €

Aku prestrihovač

DJN161 1,6 mm (16 Ga)

Li-ion



18V



Max. výkon	Železo do 400 N/mm ² : 1,6 mm Železo do 600 N/mm ² : 1,2 mm Hliník do 200 N/mm ² : 2,5 mm
Min. rádius	Vnútorňy oblúk: 45 mm Vonkajší oblúk: 50 mm
Počet strihov za minútu	1.900
Rozmery	313x78x189 mm
Hmotnosť	1,9 – 2,3 kg

DJN161RFJ
599,90 €DJN161Z
359,90 €

Aku uhlová brúska

DGA513 125 mm

Li-ion



BL ADT
MOTOR
AFT XPT (BRAKE)
EXTREME PROTECTION TECHNOLOGY

18V

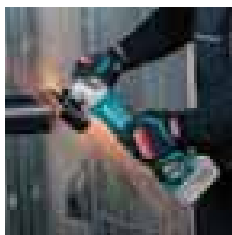

Priemer kotúča	125 mm
Voľnobežné otáčky / min ⁻¹	3.000 – 8.500
Úroveň akustického tlaku	79 dB(A)
Rozmery	s BL1815N / BL1820B: 368x140x151 mm s BL1830B / BL1840B / BL1850B / BL1860B: 382x140x151 mm
Hmotnosť	2,4 – 3,0 kg

DGA513RTJ
459,90 €DGA513ZJ
199,90 €

Aku uhlová brúska

DGA511 125 mm

Li-ion



BL ADT
MOTOR
AFT XPT
EXTREME PROTECTION TECHNOLOGY

18V

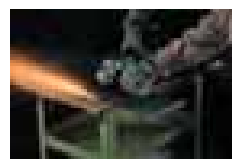

Priemer kotúča	125 mm
Voľnobežné otáčky / min ⁻¹	3.000 – 8.500
Úroveň akustického tlaku	79 dB(A)
Rozmery	s BL1815N / BL1820B: 368x140x145 mm s BL1830B / BL1840B / BL1850B / BL1860B: 382x140x145 mm
Hmotnosť	2,3 – 3,0 kg

DGA511RFJ
399,90 €DGA511Z
199,90 €

Aku uhlová brúska

DGA506 125 mm

Li-ion



BL ADT
MOTOR
AFT XPT (BRAKE)
EXTREME PROTECTION TECHNOLOGY

18V

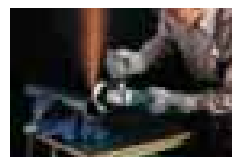

Priemer kotúča	125 mm
Voľnobežné otáčky / min ⁻¹	8.500
Úroveň akustického tlaku	79 dB(A)
Rozmery	362x140x151 mm
Hmotnosť	2,35 – 3,83 kg

DGA506RTJ
469,90 €DGA506ZJ
199,90 €

Aku uhlová brúska

DGA504 125 mm

Li-ion



BL ADT
MOTOR
AFT XPT
EXTREME PROTECTION TECHNOLOGY

18V



Priemer kotúča	125 mm
Voľnobežné otáčky / min ⁻¹	8.500
Úroveň akustického tlaku	79 dB(A)
Rozmery	362x140x145 mm
Hmotnosť	2,26 – 3,73 kg

DGA504RTJ
459,90 €DGA504ZJ
174,90 €

Aku uhlová brúska

DGA452 115 mm

Li-ion



18V

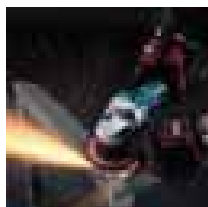

Priemer kotúča	115 mm
Voľnobežné otáčky / min ⁻¹	11.000
Úroveň akustického tlaku	76 dB(A)
Rozmery	317×129×126 mm
Hmotnosť	2,06 – 2,71 kg

DGA452RTJ
349,90 €

DGA452Z
99,90 €

Aku uhlová brúska

DGA518 125 mm

Li-ion



18V

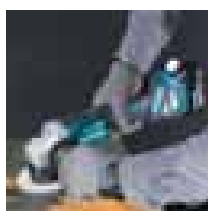

Priemer kotúča	125 mm
Voľnobežné otáčky / min ⁻¹	3.000 – 8.500
Úroveň akustického tlaku	79 dB(A)
Rozmery	s BL1815N / BL1820B: 368×140×151 mm s BL1830B / BL1840B / BL1850B / BL1860B: 382×140×151 mm
Hmotnosť	2,4 – 3,1 kg

DGA518ZJU
299,90 €

Aku priama brúska

DGD800

Li-ion



18V

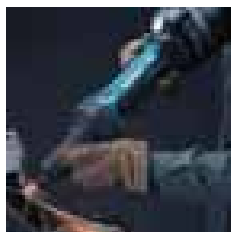

Upínanie	Klieština: 3 – 8 mm
Priemer kotúča	38 mm
Voľnobežné otáčky / min ⁻¹	26.000
Rozmery	402×82×118 mm
Hmotnosť	1,7 – 2,2 kg

DGD800RTJ
429,90 €

DGD800Z
139,90 €

Aku excentrická brúska

DBO180 125 mm

Li-ion



18V



Priemer základnej dosky	123 mm
Priemer brúsnej plochy	125 mm
Excentrický výkyv za minútu	7.000/ 9.500/ 11.000
Rozmery	175×123×153 mm
Hmotnosť	1,4 – 1,7 kg

DBO180Z
129,90 €

Aku multifunkčné náradie

DTM51

Li-ion



18V

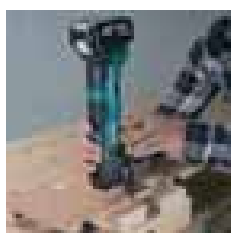

Počet kmitov za minútu	6.000 – 20.000
Uhol kmitu	Ľavý / Pravý / Spolu: 1,6° / 1,6° / 3,2°
Rozmery	340×80×122 mm
Hmotnosť	2,0 – 2,4 kg

DTM51RFJX1
449,90 €

DTM51Z
159,90 €

X1 – extra príslušenstvo

Aku pokosová píla

DLS600 165 mm

Li-ion



18V

BL ADT DXT
Drive and Exact Cutting Technology

Priemer kotúča	165 mm
Max. uhol pokosu	52° L / 52° R
Max. uhol úkosu	46° L / 46° R
Max. rezný výkon	90°: 46x92 mm
Vofnobežné otáčky / min ⁻¹	5.000
Úroveň akustického tlaku	90 dB(A)
Úroveň akustického výkonu	97 dB(A)
Vibrácie	2,5 m/s ²
Rozmery	340x400x440 mm
Hmotnosť	6,3 – 6,6 kg

DLS600Z
799,90 €

Aku kotúčová píla

DHS660 165 mm

NOVINKA

Li-ion

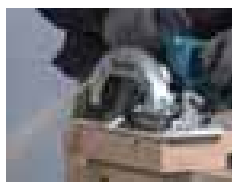

18V

BL ADT XPT
EXTREME PROTECTION TECHNOLOGY

Priemer kotúča	165 mm
Vrtanie kotúča	20 mm
Max. rezný výkon	90°: 57 mm, 45°: 41 mm, 50°: 37 mm
Vofnobežné otáčky / min ⁻¹	5.000
Úroveň akustického tlaku	93 dB(A)
Úroveň akustického výkonu	104 dB(A)
Vibrácie	2,5 m/s ²
Rozmery	270x186x250 mm
Hmotnosť	2,9 – 3,2 kg

DHS660RTJ
499,90 €DHS660ZJ
299,90 €

Aku kotúčová píla

DHS661 165 mm

NOVINKA

Li-ion

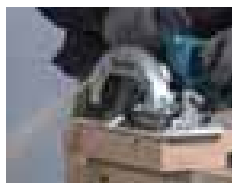

18V

BL ADT XPT
EXTREME PROTECTION TECHNOLOGY

Priemer kotúča	165 mm
Vrtanie kotúča	20 mm
Max. rezný výkon	90°: 57 mm, 45°: 41 mm, 50°: 37 mm
Vofnobežné otáčky / min ⁻¹	5.000
Úroveň akustického tlaku	93 dB(A)
Úroveň akustického výkonu	104 dB(A)
Vibrácie	2,5 m/s ²
Rozmery	270x186x250 mm
Hmotnosť	2,9 – 3,2 kg

DHS661RTJU
599,90 €DHS661ZJU
399,90 €

Aku kotúčová píla

DHS680 165 mm

Li-ion



18V

BL ADT
MOTOR

Priemer kotúča	165 mm
Max. rezný výkon	90°: 57 mm 45°: 41 mm 50°: 37 mm
Vofnobežné otáčky / min ⁻¹	5.000
Vibrácie	Pri rezaní dreva: 2,5 m/s ²
Úroveň akustického tlaku	83 dB(A)
Úroveň akustického výkonu	94 dB(A)
Rozmery	350x170x238 mm
Hmotnosť	3,0 – 3,3 kg

DHS680RTJ
529,90 €DHS680Z
259,90 €

Aku kotúčová píla

DHS630 165 mm

Li-ion



18V



Priemer kotúča	165 mm
Max. rezný výkon	90°: 66 mm 45°: 46 mm
Vofnobežné otáčky / min ⁻¹	3.100
Rozmery	346x220x247 mm
Hmotnosť	3,0 – 3,4 kg

DHS630RTJ
799,90 €

Aku kotúčová píla

DSS610 165 mm

Li-ion



18V



Priemer kotúča	165 mm
Max. rezný výkon	90°: 0 – 57 mm 45°: 0 – 40 mm 50°: 0 – 36 mm
Voľnobežné otáčky / min ⁻¹	3.700
Rozmery	347×202×228 mm
Hmotnosť	3,0 – 3,4 kg

DSS610Z
159,90 €

Aku priamočiara píla

DJV182

Li-ion



18V



Max. rezný výkon	Drevo: 135 mm Železo: 10 mm
Dĺžka kmitu	26 mm
Počet kmitov za minútu	800 – 3.500
Rozmery	266×77×208 mm
Hmotnosť	2,4 – 2,7 kg

DJV182Z
279,90 €

BL
MOTOR

Aku priamočiara píla

DJV181

Li-ion



18V



Max. rezný výkon	Drevo: 135 mm Železo: 10 mm
Dĺžka kmitu	26 mm
Počet kmitov za minútu	800 – 3.500
Rozmery	298×77×189 mm
Hmotnosť	2,3 – 2,6 kg

DJV181RTJ
529,90 €

DJV181Z
279,90 €

BL
MOTOR

Aku priamočiara píla

DJV180

Li-ion



18V



Max. rezný výkon	Drevo: 135 mm Železo: 10 mm
Dĺžka kmitu	26 mm
Počet kmitov za minútu	0 – 2.600
Rozmery	257×73×208 mm
Hmotnosť	2,7 – 3,0 kg

DJV180Z
199,90 €

Aku chvostová píla

DJR181

Li-ion



18V

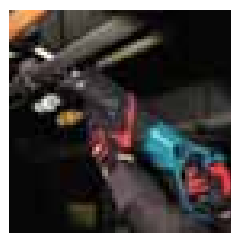

Dĺžka kmitu	28 mm
Počet kmitov za minútu	0 – 2.900
Max. rezný výkon	Rúra 130 mm Drevo: 255 mm
Rozmery	499×91×234 mm
Hmotnosť	3,7 kg

DJR181RTE
399,90 €

DJR181Z
179,90 €

Aku chvostová píla

DJR187

Li-ion



18V

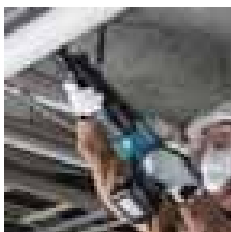

Dĺžka kmitu	32 mm
Počet kmitov za minútu	Max / Min: 0 – 3.000 / 0 – 2.300
Max. rezný výkon	Rúra: 130 mm Drevo: 255 mm
Vibrácie	Drevené platne: 16,5 m/s ² Drevené hrady: 15,5 m/s ²
Úroveň akustického tlaku	84 dB(A)
Úroveň akustického výkonu	95 dB(A)
Rozmery	439×83×231 mm
Hmotnosť	3,4 – 3,8 kg

DJR187RTE
459,90 €DJR187Z
229,90 €BL MOTOR XPT
EXTREME PROTECTION TECHNOLOGY

Aku chvostová píla

DJR186

Li-ion



18V

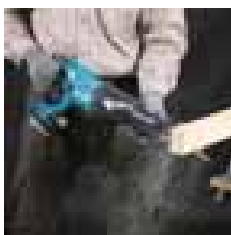

Dĺžka kmitu	32 mm
Počet kmitov za minútu	0 – 2.800
Max. rezný výkon	Rúra: 130 mm Drevo: 255 mm
Vibrácie	Drevené platne: 13,0 m/s ² Drevené hrady: 12,5 m/s ²
Úroveň akustického tlaku	84 dB(A)
Úroveň akustického výkonu	95 dB(A)
Rozmery	486×81×223 mm
Hmotnosť	3,5 – 3,8 kg

DJR186RTE
429,90 €DJR186Z
149,90 €XPT
EXTREME PROTECTION TECHNOLOGY

Aku chvostová píla

DJR183

Li-ion



18V



Max. rezný výkon	Rúra: 50 mm Drevo: 50 mm
Dĺžka kmitu	13 mm
Počet kmitov za minútu	0 – 3.000
Rozmery	392×81×209 mm
Hmotnosť	1,5 – 1,7 kg

DJR183RTJ
349,90 €DJR183Z
99,90 €

Aku chvostová píla

DJR188

Li-ion



18V



Dĺžka kmitu	20 mm
Počet kmitov za minútu	0 – 3.000
Max. rezný výkon	Rúra: 130 mm Drevo: 255 mm
Vibrácie	Drevené platne: 15,5 m/s ² Drevené hrady: 15,0 m/s ²
Úroveň akustického tlaku	83 dB(A)
Úroveň akustického výkonu	94 dB(A)
Rozmery	s BL1815N / BL1820B: 316×81×203 mm s BL1830B / BL1840B / BL1850B / BL1860B: 316×81×220 mm
Hmotnosť	2,6 – 2,9 kg

DJR188RTJ
399,90 €DJR188Z
169,90 €BL MOTOR XPT
EXTREME PROTECTION TECHNOLOGY

Aku píla na sadrokartón a OSB

DSD180

Li-ion



18V



Počet kmitov za minútu	0 – 6.000
Dĺžka kmitu	6 mm
Max. rezný výkon	Sadrokartón: 30 mm Drevo: 15 mm
Vibrácie	Rezanie sadrokartónu (hrúbka 30 mm): 2,5 m/s ² Rezanie OSB (hrúbka 15 mm): 5,0 m/s ²
Úroveň akustického tlaku	79 dB(A)
Rozmery	263×79×291 mm
Hmotnosť	1,7 – 2,0 kg

DSD180Z
239,90 €



18V



Šírka záberu	82 mm
Hĺbka hobl'ovania	2,0 mm
Voľnobežné otáčky / min ⁻¹	14.000
Rozmery	333×157×160 mm
Hmotnosť	3,2 – 3,5 kg

DKP180RTJ
469,90 €

DKP180Z
169,90 €



18V



Priemer kotúča	100 mm
Max. hĺbka rezu	20 mm
Voľnobežné otáčky / min ⁻¹	6.500
Rozmery	351×139×149 mm
Hmotnosť	2,8 – 3,1 kg

DPJ180Z
219,90 €



18V



Voľnobežné otáčky / min ⁻¹	10.000 – 30.000
Max. ponor	S orezávacou základňou: 0 – 40 mm So zanárovacou základňou: 0 – 35 mm
Vibrácie	Bez zaťaženia: 2,5 m/s ² Pri rezaní drážky v MDF: 4,5 m/s ²
Úroveň akustického tlaku	78 dB(A)
Rozmery	s BL1815N / BL1820B: 134×89×208 mm s BL1830B / BL1840B / BL1850B / BL1860B: 134×89×226 mm
Hmotnosť	1,8 – 2,1 kg

DRT50RTJX2
499,90 €

DRT50ZJX2
299,90 €

DRT50ZX4
189,90 €

X2 – ponorný nadstavec, frézovací nadstavec; X4 – vodičko, vedenie šablóny, doraz



18V



Max prietok	50 L/min
Pracovný tlak	20 Pa (150 microns)
Rychlosť motora	3.840 min ⁻¹
Objem olejovej nádoby	115 mL
Upínanie	5/16"
Rozmery	265×93×175 mm
Hmotnosť	3,5 kg

DVP180Z
349,90 €



Aku fukár

DUB182

Li-ion



18V

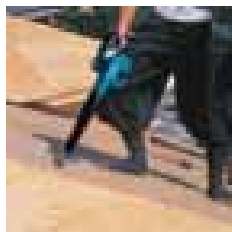

Max. prietok vzduchu	2,6 m ³ /min
Rýchlosť vzduchu	80 m/s
Tlak vzduchu	5,4 kPa (550 mmH ₂ O)
Voľnobežné otáčky / min ⁻¹	0 – 18.000
Úroveň akustického tlaku	85 dB(A)
Úroveň akustického výkonu	95 dB(A)
Vibrácie	2,5 m/s ²
Rozmery	525×155×212 mm
Hmotnosť	1,7 kg

DUB182Z
59,90 €

Aku zhutňovač

DVR450 1.200 mm

Li-ion



18V

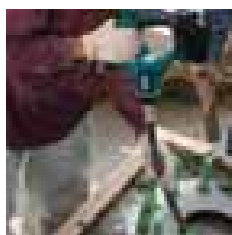

Priemer zhutňovača	25mm
Dĺžka hadice	1.200mm
Vibrácie /min/	13.000
Rozmery	1.483×93×250mm
Hmotnosť	3,3 – 3,8 kg

DVR450RTE
599,90 €DVR450Z
329,90 €

Aku pištoľ na silikón

DCG180

Li-ion



18V

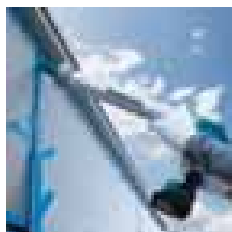

Max. tlak	5.000 N
Voľnobežné otáčky / min ⁻¹	0 – 28 mm/sec. (0 – 66 in/min.)
Veľkosť nastavcov	300, 600, 800 mL
Úroveň akustického tlaku	70 dB(A)
Vibrácie	Bez zaťaženia: 2,5 m/s ²
Rozmery	404×108×281 mm
Hmotnosť	2,1 – 3,0 kg

DCG180RF
369,90 €DCG180Z
219,90 €

Aku klinovačka

DPT353

Li-ion



18V



Dĺžka klincov	Dĺžka: 15, 18, 25, 30, 35 mm
	Priemer: 0,6 mm
	Kaliber: 23 Ga
Kapacita zásobníka	120
Vibrácie	2,5 m/s ²
Úroveň akustického tlaku	76 dB(A)
Rozmery	257×79×226 mm
Hmotnosť	2,0 – 2,3 kg

DPT353RFJ
599,90 €DPT353Z
369,90 €

Aku sponkovačka

DST221

Li-ion



18V



Sponky	Šírka: 10 mm
	Dĺžka: 10, 13, 16, 19, 22 mm
	Kaliber: 0,6×1,2 mm
Kapacita zásobníka	98
Vibrácie	3,5 m/s ²
Úroveň akustického tlaku	82 dB(A)
Úroveň akustického výkonu	93 dB(A)
Rozmery	251×91×212 mm
Hmotnosť	2,1 – 2,4 kg

DST221Z
289,90 €

Aku sponkovačka

DST112

Li-ion



18V



Spunky	Šírka: 10 mm
	Dĺžka: 7 - 10 mm
	Kaliber: 0,5x0,7 mm
Kapacita zásobníka	150 (max 160)
Počet klincov s 3,0 Ah	s BL1830B: 6.000
Vibrácie	2,5 m/s ²
Úroveň akustického tlaku	76 dB(A)
Rozmery	235x79x165 mm
Hmotnosť	1,5 - 1,8 kg

DST112Z
299,90 €

XPT
EXTREME PROTECTION TECHNOLOGY

Aku píla

DUC254 250 mm

NOVINKA

Li-ion



18V

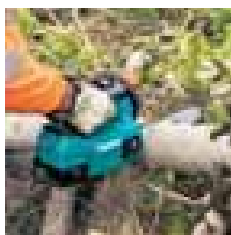

Dĺžka lišty	250 mm
Delenie reťaze	3/8"
Šírka drážky	1,1 mm
Rychlosť reťaze	0 - 24 m/s (0 - 1 440 m/min)
Nádrž na olej	140 mL
Úroveň akustického tlaku	92,2 dB(A)
Úroveň akustického výkonu	103,2 dB(A)
Vibrácie pri rezaní dreva:	3,1 m/s ²
Hmotnosť	2,8 - 3,2 kg

DUC254Z
249,90 €

BL MOTOR XPT
EXTREME PROTECTION TECHNOLOGY

Aku píla

DUC122 115 mm

Li-ion



18V

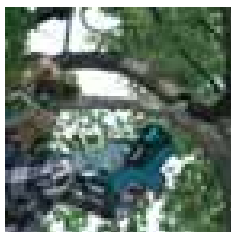

Dĺžka lišty	115 mm
Delenie reťaze	1/4"
Šírka drážky	1,3 mm
Rychlosť reťaze	5,0 m/s (300 m/min) (980 FPM)
Nádrž na olej	80 mL
Úroveň akustického tlaku	84,6 dB(A)
Úroveň akustického výkonu	92,7 dB(A)
Vibrácie	Pri rezaní dreva: 4,3 m/s ²
Rozmery	422x195x215 mm
Hmotnosť	2,6 kg

DUC122Z
159,90 €

Aku plotostrih

DUH523 520 mm

Li-ion



18V



Dĺžka noža	520 mm
Počet strihov za minútu	2.700
Rozstup nožov	26 mm
Úroveň akustického tlaku	77 dB(A)
Úroveň akustického výkonu	84,3 dB(A)
Vibrácie	2,5 m/s ²
Rozmery	938x195x193 mm
Max. výkon	210 W
Hmotnosť	3,0 - 3,4 kg

DUH523Z
109,90 €

Aku vyžinač

DUR189

Li-ion



18V



Voľnobežné otáčky / min ⁻¹	Max / Priemer / Min / ADT mód
Šírka rezného nástroja	6.000 / 5.000 / 4.000 / 4.000 - 6.000
	Zacia hlava: 300 mm
	Plastový nôž: 255 mm
Uchytenie nástroja na vretene	M8x1,25 RH
Rozmery	1.518 - 1.618x258x369 mm
Hmotnosť	3,1 - 3,4 kg

DUR189Z
199,90 €

BL MOTOR ADT

Aku vyžinač

DUR187 / DUR188

Li-ion



18V

BL ADT XPT
 MOTOR EXTREME PROTECTION TECHNOLOGY

Sírka rezného nástroja	Žacia hlava: 300 mm
	Plastový nôž: 255 mm
Voľnoběžné otáčky / min ⁻¹	Max / Priemer / Min / ADT mód
	6.000 / 5.000 / 4.000 / 4.000 – 6.000
Uchytenie nástroja na vretene	M8x1,25 LH
Úroveň akustického tlaku	Žacia hlava: 74 dB(A)
Úroveň akustického výkonu	Žacia hlava: 84 dB(A)
Úroveň akustického tlaku	Plastový nôž: 79 dB(A)
Úroveň akustického výkonu	Plastový nôž: 88 dB(A)
Vibrácie	Vpred/vzad: 2,5 / 2,5 m/s ²
Rozmery	1.791x600x472 mm
Hmotnosť	DUR187U : 3,2 – 3,5 kg
	DUR188U : 3,5 – 3,8 kg

DUR187UZ
 179,90 €

DUR188UZ
 219,90 €

Aku vyžinač

DUR187L

Li-ion



18V

BL ADT XPT
 MOTOR EXTREME PROTECTION TECHNOLOGY

Sírka rezného nástroja	Žacia hlava: 300 mm
	Plastový nôž: 255 mm
Voľnoběžné otáčky / min ⁻¹	Max / Priemer / Min / ADT mód
	6.000 / 5.000 / 4.000 / 4.000 – 6.000
Uchytenie nástroja na vretene	M8x1,25 LH
Úroveň akustického tlaku	Žacia hlava: 74 dB(A)
Úroveň akustického výkonu	Žacia hlava: 84 dB(A)
Úroveň akustického tlaku	Plastový nôž: 79 dB(A)
Úroveň akustického výkonu	Plastový nôž: 88 dB(A)
Vibrácie	Vpred/vzad: 2,5 / 2,5 m/s ²
Rozmery	1.791x258x232 mm
Hmotnosť	DUR187L : 3,4 – 3,7 kg
	DUR188L : 3,7 – 4,0 kg

DUR187LZ
 179,90 €

Aku vyžinač

DUR184

NOVINKA

Li-ion



18V

BL XPT
 MOTOR EXTREME PROTECTION TECHNOLOGY

Sírka rezného nástroja	Žacia hlava: 300 mm
Voľnoběžné otáčky	max / min 6.000 / 5.000
Uchytenie nástroja na vretene	M8x1,25 RH
Úroveň akustického tlaku	Žacia hlava: 77 dB(A)
Úroveň akustického výkonu	Žacia hlava: 89 dB(A)
Vibrácie	Vpred/vzad: 2,5 / 2,5 m/s ²
Rozmery	1.534 – 1.634x258x417 mm
Hmotnosť	3,3 – 3,6 kg

DUR184LZ
 199,90 €

Aku vyžinač

DUR181

Li-ion



18V



Sírka rezného nástroja	Žacia hlava: 260 mm
Voľnoběžné otáčky / min ⁻¹	7.800
Úroveň akustického tlaku	82 dB(A)
Úroveň akustického výkonu	88,5 dB(A)
Vibrácie	2,5 m/s ²
Rozmery	1.229 – 1.433x267x186 – 257 mm
Hmotnosť	2,8 – 3,1 kg

DUR181Z
 99,90 €

Aku nožnice na trávnu

DUM604 160 mm

Li-ion



18V

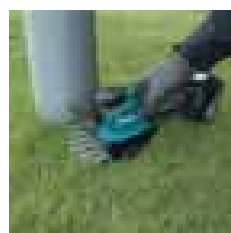

Sírka rezného nástroja	160 mm
Nastavenie výšky strihu	15, 20, 25 mm
Počet strihov za minútu	2.500
Úroveň akustického tlaku	76 dB(A)
Vibrácie	2,5 m/s ²
Rozmery	337x177x131 mm
Hmotnosť	1,4 – 1,8 kg

DUM604RF
 179,90 €

DUM604ZX
 99,90 €

X – nôž na trávnu/nôž na živý plot



18V

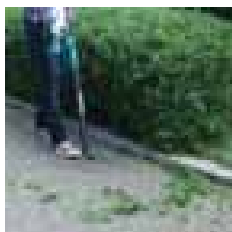

Max. prietok vzduchu	2,6 m ³ /min
Rychlosť vzduchu	52 m/s
Vôľnobežné otáčky / min ⁻¹	0 - 18.000
Úroveň akustického tlaku	85 dB(A)
Úroveň akustického výkonu	95 dB(A)
Vibrácie	2,5 m/s ²
Rozmery	845×155×212 mm
Hmotnosť	1,7 - 2,0 kg

DUB183Z
64,90 €



Toto video bolo natočené v Japonsku.
Modely a špecifikácie sa môžu líšiť.



12V^{max}
LITHIUM-ION



ROZŠÍRTE SI SVOJ AKU SORTIMENT

4.0Ah 2.0Ah 1.5Ah

Multi Line Laser SK209GD / SK312GD

CJ102D / CJ105D / CJ106D

CV102D

CF100D / CF101D

DFV210

DFJ210 / DFJ211 / DFJ310 / DFJ311 / DFJ410 / DFJ411 / DFJ212 / DFJ213 / DFJ214

CL106D / CL107D / CL108D / CL121D

UH201D

CG100D

DMR200 / DMR201 / DMR202

SK105GD / SK105D / SK106GD / SK106D

DMR107 / DMR108 / DMR109 / DMR110 / DMR112 / MR052

DF332D / DF032D / DF333D / DF033D

DA332D / DA333D

HP332D / HP333D

TD110D / TD111D

TW140D / TW141D / TW160D / TW161D / TW060D

TL064D / TL065D

CP100D

JR103D / JR105D

PT354D

TM30D

ADP08 / ADP06

HR140D / HR166D

HS301D

CC301D

SD100D

JV101D / JV102D / JV103D

ST113D

UM600D

UR100D



Aku skrutkovač

DF333D 10 mm / DF033D 1/4"

NOVINKA

Li-ion



DF033D



DF333D

12V_{MAX}



DF333DSAE
139,90 €

DF333DSME
169,90 €

DF333DZ
59,90 €

DF033DSAE
139,90 €

DF033DZ
44,90 €

	DF333D	DF033D
Max. vrtací výkon	Železo / Drevo: 10 / 21 mm	Železo / Drevo: 10 / 21 mm
Rozsah skľučovadla	0,8 – 10 mm	1/4"
Voľnobežné otáčky / min ⁻¹	Max / Min: 0 – 1.700 / 0 – 450	Max / Min: 0 – 1.700 / 0 – 450
Max. uťahovací moment	Tvrдый / mäkký spoj: 30 / 14 N·m	Tvrдый / mäkký spoj: 30 / 14 N·m
Max. povoľovací moment	28 N·m	28 N·m
Vibrácie	Vŕtanie do železa: 2,5 m/s ²	
Úroveň akustického tlaku	70 dB(A)	70 dB(A)
Max. výkon	170 W	170 W
Rozmery	179×66×229 mm	149×66×229 mm
Hmotnosť	1,1 – 1,2 kg	0,9 – 1,1 kg

Aku skrutkovač

DF332D 10 mm / DF032D 1/4"

Li-ion



DF332D



DF032D

12V_{MAX}



DF332DSAE
199,90 €

DF332DSME
229,90 €

DF332DZ
119,90 €

DF032DSAE
199,90 €

DF032DSME
229,90 €

DF032DZ
119,90 €

	DF332D	DF032D
Max. vrtací výkon	Železo / Drevo: 10 / 28 mm	Železo / Drevo: 10 / 28 mm
Rozsah skľučovadla	0,8 – 10 mm	1/4"
Voľnobežné otáčky / min ⁻¹	Max / Min: 0 – 1.500 / 0 – 450	Max / Min: 0 – 1.500 / 0 – 450
Max. uťahovací moment	Tvrдый / mäkký spoj: 35 / 21 N·m	Tvrдый / mäkký spoj: 35 / 21 N·m
Max. povoľovací moment	32 N·m	32 N·m
Vibrácie	Vŕtanie do železa: 2,5 m/s ²	Vŕtanie do železa: 2,5 m/s ²
Úroveň akustického tlaku	72 dB(A)	71 dB(A)
Max. výkon	250 W	250 W
Rozmery	154×66×217 mm	124×66×217 mm
Hmotnosť	1,0 – 1,2 kg	0,88 – 1 kg

Aku skrutkovač

DF331D 10 mm

Li-ion



DF331D

12V_{MAX}



DF331DSAX6
199,90 €

DF331DSAE
139,90 €

Do vypredania zásob; X6 – chladiaci systém, taška

Aku skrutkovač

HP333D 10 mm

NOVINKA

Li-ion



12V_{MAX}



HP333DSAE
154,90 €

HP333DZ
64,90 €

Max. vrtací výkon	Železo / Drevo / Murivo: 10 / 21 / 8 mm
Rozsah skľučovadla	0,8 – 10 mm
Počet úderov za minútu	Max / Min: 0 – 25.500 / 0 – 6.750
Voľnobežné otáčky / min ⁻¹	Max / Min: 0 – 1.700 / 0 – 450
Max. uťahovací moment	Tvrдый / mäkký spoj: 30 / 14 N·m
Max. povoľovací moment	28 N·m
Vibrácie	Vŕtanie s príklepom do betónu: 13 m/s ² Vŕtanie do železa: 2,5 m/s ²
Úroveň akustického tlaku	82 dB(A)
Úroveň akustického výkonu	93 dB(A)
Rozmery	193×66×229 mm
Hmotnosť	1,1 – 1,3 kg

Aku skrutkovač

HP332D 10 mm

Li-ion



12V_{MAX}



HP332DSAE
209,90 €

HP332DSME
239,90 €

HP332DZ
129,90 €

Max. vrtací výkon	Železo / Drevo / Murivo: 10 / 28 / 8 mm
Rozsah skľučovadla	0,8 – 10 mm
Počet úderov za minútu	Max / Min: 0 – 22.500 / 0 – 6.750
Voľnobežné otáčky / min ⁻¹	Max / Min: 0 – 1.500 / 0 – 450
Max. uťahovací moment	Tvrдый / mäkký spoj: 35 / 21 N·m
Max. povoľovací moment	32 N·m
Vibrácie	Vŕtanie s príklepom do betónu: 12,5 m/s ² Vŕtanie do železa: 2,5 m/s ²
Úroveň akustického tlaku	82 dB(A)
Úroveň akustického výkonu	93 dB(A)
Rozmery	168×66×217 mm
Hmotnosť	1,1 – 1,3 kg

Aku uhlová vrtáčka

DA333D / DA332D 10 mm

Li-ion

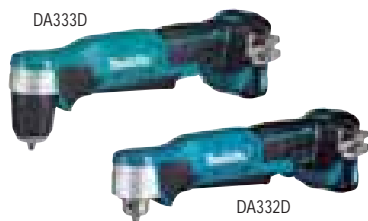
12V_{MAX}

CXT



	DA333D	DA332D
Max. vrtací výkon	Železo: 10 mm Drevo: 12 mm	Železo: 10 mm Drevo: 12 mm
Voľnobežné otáčky / min ⁻¹	0 - 1.100	0 - 1.100
Výška hlavy	84 mm	63 mm
Výška tela stroja	23,5 mm	23,5 mm
Vibrácie	Vŕtanie do železa: 3,0 m/s ²	Vŕtanie do železa: 2,5 m/s ²
Úroveň akustického tlaku	70 dB(A)	70 dB(A)
Rozmery	s BL1016/BL1021B : 313×68×95 mm s BL1041B : 332×68×95 mm	s BL1016/BL1021B : 313×68×86 mm s BL1041B : 332×68×86 mm
Hmotnosť	1,2 - 1,4 kg	1,2 - 1,3 kg

DA333DSAE
209,90 €DA333DZ
89,90 €DA332DSAE
199,90 €DA332DZ
99,90 €

Aku rázový uťahovač

TW060D

NOVINKA

Li-ion

12V_{MAX}

CXT



Max. uťahovací výkon	Skrutka štandardná M8 - M12 Skrutka vysokopevnosťná M6 - M10
Upínanie	1/4"
Voľnobežné otáčky / min ⁻¹	0 - 2.600
Počet úderov za minútu	0 - 3.200
Max. uťahovací moment	60 N·m
Hmotnosť	1,0 - 1,2 kg

TW060DSAE
189,90 €TW060DZ
59,90 €

Aku rázový uťahovač

TW140D

Li-ion

12V_{MAX}

CXT



Max. uťahovací výkon	Skrutka štandardná: M8 - M16 Skrutka vysokopevnosťná: M6 - M12
Upínanie	1/4"
Voľnobežné otáčky / min ⁻¹	0 - 2.600
Počet úderov za minútu	0 - 3.200
Max. uťahovací moment	140 N·m
Hmotnosť	1,0 - 1,2 kg

TW140DSAEX
199,90 €TW140DSMJ
229,90 €TW140DZ
59,90 €

X - sada nastrčkových kľúčov

Aku rázový skrutkovač

TD111D

Li-ion

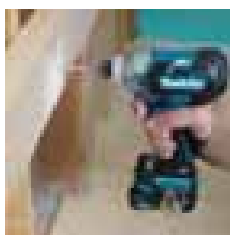
12V_{MAX}CXT BL MOTOR XPT
EXTREME PROTECTION TECHNOLOGY

Max. uťahovací výkon	Skrutka so šesťhrannou hlavou: M4 - M8 mm Skrutka štandardná: M5 - M14 Skrutka vysokopevnosťná: M5 - M12
Upínanie	1/4"
Voľnobežné otáčky / min ⁻¹	Tvrдый / mäkký spoj: 0 - 3.000 / 0 - 1.300
Počet úderov za minútu	Tvrдый / mäkký spoj: 0 - 3.900 / 0 - 1.600
Max. uťahovací moment	135 N·m
Vibrácie	12,5 m/s ²
Úroveň akustického tlaku	94 dB(A)
Úroveň akustického výkonu	105 dB(A)
Rozmery	135×66×210 mm
Hmotnosť	0,97 - 1,1 kg

TD111DSAE
249,90 €TD111DZ
109,90 €

Aku rázový skrutkovač

TD110D

Li-ion

12V_{MAX}

CXT

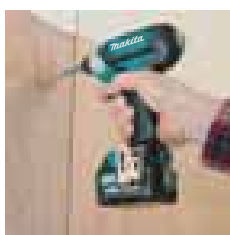

Max. uťahovací výkon	Skrutka so šesťhrannou hlavou: M4 - M8 mm Skrutka štandardná: M5 - M12 Skrutka vysokopevnosťná: M5 - M10
Upínanie	1/4"
Voľnobežné otáčky / min ⁻¹	0 - 2.600
Počet úderov za minútu	0 - 3.500
Max. uťahovací moment	110 N·m
Vibrácie	8,0 m/s ²
Úroveň akustického tlaku	94 dB(A)
Úroveň akustického výkonu	105 dB(A)
Max. výkon	120 W
Rozmery	153×66×204 mm
Hmotnosť	1,0 - 1,2 kg

TD110DSAE
169,90 €TD110DSME
199,90 €TD110DZ
49,90 €

Aku uhlový rázový skrutkovač

TL064D

Li-ion



12V_{MAX}



CXT



Max. űahovací výkon	Skrutka so šesthrannou hlavou: M4 – M8 Skrutka standardná: M4 – M12 Skrutka vysokopevnostná: M4 – M8
Upínanie	1/4"
Voľnobežné otáčky / min ⁻¹	0 – 2.000
Počet úderov za minútu	0 – 3.000
Max. űahovací moment	60 N·m
Vibrácie	15,0 m/s ²
Úroveň akustického tlaku	91 dB(A)
Úroveň akustického výkonu	102 dB(A)
Rozmery	361×66×86 mm
Hmotnosť	1,2 – 1,6 kg

TL064DSAJ
329,90 €

TL064DZ
199,90 €

Aku uhlový rázový skrutkovač

TL065D

Li-ion



12V_{MAX}



CXT



Max. űahovací výkon	Skrutka standardná: M4 – M12 Skrutka vysokopevnostná: M4 – M8
Upínanie	3/8"
Voľnobežné otáčky / min ⁻¹	0 – 2.000
Počet úderov za minútu	0 – 3.000
Max. űahovací moment	60 N·m
Vibrácie	18,0 m/s ²
Úroveň akustického tlaku	90 dB(A)
Úroveň akustického výkonu	101 dB(A)
Rozmery	361×66×86 mm
Hmotnosť	1,2 – 1,6 kg

TL065DSAJ
349,90 €

TL065DZ
199,90 €

Aku vŕtacie kladivo

HR166D 16 mm

Li-ion



12V_{MAX}



CXT BL MOTOR

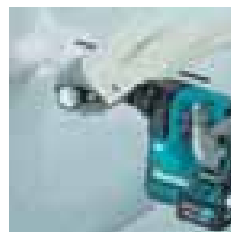

Energia priklepu	EPTA-Procedure 05/2009: 1,1 J
Max. vŕtací výkon	Betón: 16 mm Železo: 10 mm Drevo: 13 mm
Počet úderov / min ⁻¹	0 – 4.800
Voľnobežné otáčky / min ⁻¹	0 – 680
Vibrácie	Vŕtanie s príklepom do betónu: 7,5 m/s ² Vŕtanie do železa: 2,5 m/s ²
Úroveň akustického tlaku	86 dB(A)
Úroveň akustického výkonu	97 dB(A)
Rozmery	s BL1016/BL1021B: 250×74×187 mm s BL1041B: 250×74×206 mm
Hmotnosť	1,8 – 2,4 kg

HR166DSMJ
299,90 €

HR166DZ
149,90 €

Aku vŕtacie kladivo

HR140D 14 mm

Li-ion



12V_{MAX}



CXT



Energia priklepu	EPTA-Procedure 05/2009: 1,0 J
Max. vŕtací výkon	Betón: 14 mm Železo: 10 mm Drevo: 13 mm
Počet úderov za minútu	0 – 4.900
Voľnobežné otáčky / min ⁻¹	0 – 850
Vibrácie	Vŕtanie s príklepom do betónu: 6,5 m/s ² Vŕtanie do železa: 3,0 m/s ²
Úroveň akustického tlaku	84 dB(A)
Úroveň akustického výkonu	95 dB(A)
Rozmery	s BL1016/BL1021B: 246×74×179 mm s BL1041B: 246×74×198 mm
Hmotnosť	1,9 – 2,6 kg

HR140DSMJ
269,90 €

HR140DWY1
229,90 €

HR140DZ
109,90 €

1 – sada príslušenstva

Aku rezačka na mokro

CC301D 85 mm

Li-ion



12V_{MAX}



CXT

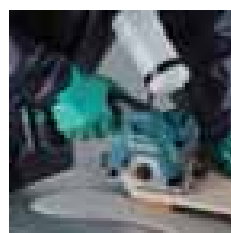

Priemer kotúča	85 mm
Max. rezný výkon	90°: 25,5 mm 45°: 16,5 mm
Voľnobežné otáčky / min ⁻¹	1.600
Objem nádrže	Voda: 0,5 L
Vibrácie	Rez v betóne: 2,5 m/s ²
Úroveň akustického tlaku	84 dB(A)
Úroveň akustického výkonu	95 dB(A)
Rozmery	313×170×125 mm
Hmotnosť	1,9 kg

CC301DSMJ
329,90 €

CC301DZ
139,90 €

Aku rezač

CP100D

Li-ion

12V_{MAX}

Max. rezný výkon	6 mm
Voľnoběžné otáčky / min ⁻¹	300
Vibrácie	Rez kartónu: 2,5 m/s ²
Úroveň akustického tlaku	70 dB(A)
Rozmery	s BL1016/BL1021B: 272×66×120 mm s BL1041B: 291×66×121 mm
Hmotnosť	0,72 – 0,88 kg

CP100DWA
149,90 €

CXT

Aku multifunkčné náradie

TM30D

Li-ion

12V_{MAX}

Počet kmitov za minútu	6 000 – 20 000
Uhol kmitu	Vľavo/vpravo/spolu: 1,6° / 1,6° / 3,2°
Max. výkon	170 W
Hmotnosť	1,1 – 1,3 kg

TM30DWEY
179,90 €TM30DZ
79,90 €

CXT

Aku kotúčová píla

HS301D 85 mm

Li-ion

12V_{MAX}

Priemer kotúča	85 mm
Max. rezný výkon	90°: 25,5 mm 45°: 16,5 mm
Voľnoběžné otáčky / min ⁻¹	1 500
Vibrácie	Rez v dreve: 2,5 m/s ²
Úroveň akustického tlaku	71 dB(A)
Max. výkon	160 W
Rozmery	313×170×155 mm
Hmotnosť	1,6 – 1,7 kg

HS301DSME
229,90 €HS301DZ
89,90 €

CXT

Aku priamočiara píla

JV103D

Li-ion

12V_{MAX}

Max. rezný výkon pri 90°	Drevo/hlinik/mäkká oceľ: 90 / 20 / 10 mm
Dĺžka kmitu	23 mm
Počet kmitov za minútu	800 – 3 000
Vibrácie	Rez v drevených platniach: 8,5 m/s ² Rez v železných platniach: 6,0 m/s ²
Úroveň akustického tlaku	85 dB(A)
Úroveň akustického výkonu	96 dB(A)
Rozmery	237×76×206 mm
Hmotnosť	1,9 – 2,0 kg

JV103DSMJ
299,90 €JV103DZ
149,90 €CXT BL
MOTOR

Aku priamočiara píla

JV102D

Li-ion

12V_{MAX}

Max. rezný výkon pri 90°	Drevo/hlinik/mäkká oceľ: 90 / 20 / 10 mm
Dĺžka kmitu	23 mm
Počet kmitov za minútu	800 – 3 000
Vibrácie	Rez v drevených platniach: 11,5 m/s ² Rez v železných platniach: 9,5 m/s ²
Úroveň akustického tlaku	85 dB(A)
Úroveň akustického výkonu	96 dB(A)
Rozmery	237×76×186 mm
Hmotnosť	1,8 – 1,9 kg

JV102DZ
149,90 €CXT BL
MOTOR

Aku priamočiara píla

JV101D

Li-ion



12V_{MAX}

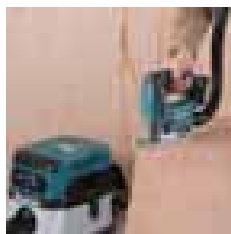

Max. rezný výkon pri 90°	Drevo/hlinik/mäkka oceľ:
	65 / 4 / 2 mm
Dĺžka kmitu	18 mm
Počet kmitov za minútu	0 – 2.900
Vibrácie	Rez v drevených platniach: 7,0 m/s ² Rez v železných platniach: 5,5 m/s ²
Úroveň akustického tlaku	80 dB(A)
Úroveň akustického výkonu	91 dB(A)
Rozmery	232×76×196 mm
Hmotnosť	1,8 – 1,9 kg

JV101DSME
239,90 €

JV101DZ
79,90 €

CXT

Aku chvostová píla

JR105D / JR103D

Li-ion



12V_{MAX}



JR105D



Dĺžka kmitu	13 mm
Počet kmitov za minútu	0 – 3.300
Max. rezný výkon	Rúra/drevo: 50 / 50 mm
Vibrácie	Rez platni: 8,0 m/s ² Drevené hrady: 8,0 m/s ²
Úroveň akustického tlaku	78 dB(A)
Max. výkon	210 W
Rozmery	376×66×186 mm
Hmotnosť	1,3 – 1,5 kg

JR105DSME
229,90 €

JR105DZ
79,90 €

JR103DSAE
199,90 €

JR103DSME
249,90 €

JR103DZ
89,90 €

CXT

Aku ventilátor

CF101D

NOVINKA

Li-ion



12V_{MAX}



Pracovný čas (min.)	s BL1041B: Min. / Priemer / Max.: 630 / 380 / 275
Rozmery	185×260×284 mm
Hmotnosť	1,3 – 1,7 kg

Dodávaný bez sieťového adaptéra

CF101DZ
69,90 €

CXT

Aku sponkovačka

ST113D

Li-ion



12V_{MAX}



Sponky	Šírka: 10 mm Dĺžka: 7 – 10 mm Kaliber: 0,5×0,7 mm
Kapacita zásobníka	150 (max 160)
Vibrácie	2,5 m/s ²
Úroveň akustického tlaku	75 dB(A)
Rozmery	211×81×159 mm
Hmotnosť	1,3 kg

ST113DSAJ
399,90 €

ST113DZ
299,90 €

CXT XPT
EXTREM PROTECTION TECHNOLOGY

Aku klincovačka /pinky/

PT354D

Li-ion



12V_{MAX}



Klince /pinky/	Dĺžka: 15. 18. 25. 30. 35 mm Priemer: 0,6 mm Kaliber: 23 Ga
Kapacita zásobníka	120
Vibrácie	2,5 m/s ²
Úroveň akustického tlaku	76 dB(A)
Rozmery	231×66×226 mm
Hmotnosť	1,8 – 2,0 kg

PT354DZ
349,90 €

CXT

Aku pištoľ na silikón

CG100D

Li-ion

12V_{MAX}

CXT



Max. tlak	5.000 N
Voľnobežné otáčky / min ⁻¹	0 – 28 mm/sec. (0 – 66 in./min.)
Veľkosť nastavcov	300. 600. 800 mL
Uroveň akustického tlaku	70 dB(A)
Vibrácie	Bez zafázenia: 2,5 m/s ²
Rozmery	404x108x259 mm
Hmotnosť	1,9 – 2,6 kg

CG100DSAA
329,90 €CG100DZA
199,90 €

Aku vyžinač

UR100D

Li-ion

12V_{MAX}CXT XPT
EXTREME PROTECTION TECHNOLOGY

Sírka rezného nástroja	Zacia hlava: 260 mm
	Plastový nôž: 230 mm
Voľnobežné otáčky / min ⁻¹	Zacia hlava: 9.000
	Plastový nôž: 10.000
Uchytenie nástroja na vretene	M8x1,25 RH
Rozmery	835 – 1.185x267x210 – 315 mm
Hmotnosť	2,1 – 2,3 kg

UR100DSAEX
179,90 €UR100DWAE
169,90 €UR100DZ
89,90 €UR100DZX
89,90 €

X – plastový nôž

Aku plotostrih

UH201D 200 mm

Li-ion

12V_{MAX}CXT 2in1 XPT
EXTREME PROTECTION TECHNOLOGY

Dĺžka rezného noža	200 mm
Rozostup nožov	26 mm
Počet strihov za minútu	2.500
Uroveň akustického tlaku	74 dB(A)
Vibrácie	2,5 m/s ²
Rozmery	504x120x131 mm
Hmotnosť	1,3 – 1,5 kg

UH201DZ
59,90 €

Aku strihač trávy

UM600D 160 mm

Li-ion

12V_{MAX}CXT 2in1 XPT
EXTREME PROTECTION TECHNOLOGY

Sírka rezného nástroja	160 mm
Nastavenie výšky strihu	15. 20. 25 mm
Počet strihov za minútu	2.500
Uroveň akustického tlaku	75 dB(A)
Vibrácie	2,5 m/s ²
Rozmery	329x177x131 mm
Hmotnosť	1,3 – 1,5 kg

UM600DWAEX
159,90 €UM600DZX
99,90 €

X – nôž na trávu/nôž na živý plot

Aku / elektrické LED svetlo

DML805 18 V, 14.4 V / AC

Li-ion



18V

14.4V



Čas svietenia	Max 17 hodin /podľa akumulátora/
Svietivosť	Max: 750 lm. Min: 450 lm
Hmotnosť	2,3 – 2,7 kg
Dĺžka privodného kábla	2,5 m

DEADML805
149,90 €

Aku LED lampa

DML802 18 V, 14.4 V

Li-ion



18V 14.4V

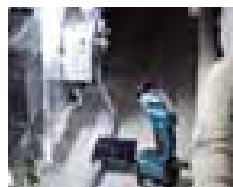

Čas svietenia	Max 27 hodín /podľa akumulátora/
Rozmery	272×79×116 mm
Hmotnosť	0,64 – 1,0 kg

DEADML802
49,90 €

Aku LED lampa

ML105 12 V max

Li-ion

12V_{MAX}

Čas svietenia	Max 14 hodín /podľa akumulátora/
Svietivosť	190 lm
Rozmery	s BL1016/BL1021B: 249×66×93 mm s BL1041B: 268×66×93 mm
Hmotnosť	0,53 – 0,70 kg

DEAML105
49,90 €

CXT

Aku LED lampa

ML104 12 V max

Li-ion

12V_{MAX}

Čas svietenia	Max 19 hodín /podľa akumulátora/
Rozmery	414×66×132 mm
Hmotnosť	0,61 – 0,78 kg

DEAML104
89,90 €CXT XPT
EXTREME PROTECTION TECHNOLOGY

Aku LED lampa

DML801 18 V, 14.4 V

Li-ion



18V 14.4V



Čas svietenia	Max 48 hodín /podľa akumulátora/
Rozmery	380×79×116 mm
Hmotnosť	0,61 – 0,98 kg

DEADML801
49,90 €

Aku lampa

DML185

Li-ion



DML185

18V



Čas svietenia	
Max minút /podľa akumulátora/	550
Čelková dĺžka	284 mm
Hmotnosť	0,71 – 1,03 kg

DEADML185
26,90 €

Aku LED lampa

DML186

Li-ion



DML186

18V



Čas svietenia	
Max hodin /podľa akumulátora/:	114
Rozmery	151×81×61 mm
Hmotnosť	0,51 – 0,83 kg

DEADML186
19,90 €

Aku LED lampa

ML103

Li-ion

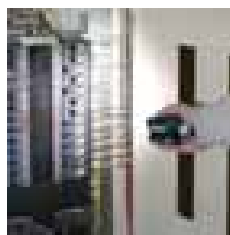
12V_{MAX}

Čas svietenia	Max 28 hodin /podľa akumulátora/
Rozmery	bez akumulátora: 77×54×28 mm s BL1016/BL1021B: 87×64×54 mm s BL1041B: 87×64×73 mm
Hmotnosť	0,27 – 0,43 kg

DEAML103
27,90 €

CXT

Aku ventilátor

DCF300 18 V, 14.4 V / AC

Li-ion



18V

14.4V



Pracovný čas (min.)	Max.: 55–3,0 Ah. 25–1,3 Ah (18 V) / 50–3,0 Ah. 22–1,3 Ah (14,4 V) Priemer: 90–3,0 Ah. 40–1,3 Ah (18 V) / 80–3,0 Ah. 35–1,3 Ah (14,4 V) Min.: 180–3,0 Ah. 80–1,3 Ah (18 V) / 160–3,0 Ah. 70–1,3 Ah (14,4 V)
Rozmery	315×480×600 mm
Hmotnosť	4,3 – 4,7 kg

DCF300Z
129,90 €

Aku ventilátor

DCF201 18 V, 14.4 V / AC

Li-ion



18V

14.4V



Pracovný čas (min.)	Max.: 100–3,0 Ah. 45–1,3 Ah (18 V) / 90–3,0 Ah. 40–1,3 Ah (14,4 V) Min.: 200–3,0 Ah. 90–1,3 Ah (18 V) / 180–3,0 Ah. 80–1,3 Ah (14,4 V)
Rozmery	263×330×523 mm
Hmotnosť	2,5 – 2,9 kg

DCF201Z
89,90 €

Aku ventilátor

DCF102

Li-ion



18V

14.4V



Pracovný čas (min.)	s BL1860B: Min. / Priemer / Max.: 1270 / 705 / 575
Rozmery	185×272×284 mm
Hmotnosť	1,3 – 2,0 kg

DCF102Z
69,90 €



Objem nádoby na vodu 250 mL 225×186×217 mm
 Rozmery s BL1016/BL1021B: 87×64×54 mm
 Hmotnosť 1,9 kg

Použitie len na akumulátory.

18V 14.4V 12V_{MAX}

DCM501Z
109,90 €



Pracovný čas (hod.) s BL1860B Min. / Priemer / Max.:
40 / 26,5 / 18,5
 Prúdenie vzduchu Turbo / Max. / Priemer / Min.:
2,1 / 1,9 / 1,5 / 1,3 m³/min
 Veľkosť S / M / L / XL / 2XL / 3XL
 Počet vreciek 5
 Hmotnosť DFJ206: 360 g
 DFJ207: 380 g

Dodávané bez adaptéra na akumulátor

18V 14.4V 12V_{MAX}

DFJ206Z2XL
79,90 €

DFJ206Z3XL
79,90 €

DFJ206ZL
79,90 €

DFJ206ZXL
79,90 €

DFJ207ZL
85,90 €

DFJ207ZXL
85,90 €

DFJ207Z2XL
85,90 €



Veľkosť L / XL / 2XL

Dodávané bez adaptéra na akumulátor

18V 14.4V 12V_{MAX}

DFJ212Z2XL
159,90 €

DFJ212ZL
159,90 €

DFJ212ZXL
159,90 €



Veľkosť L / XL / 2XL

Dodávané bez adaptéra na akumulátor

18V 14.4V 12V_{MAX}

DFJ213Z2XL
149,90 €

DFJ213ZL
149,90 €

DFJ213ZXL
149,90 €



Aku chladiaca bunda

DFJ304 / DFJ305 18 V, 14.4 V, 12 V max

Li-ion



DFJ304



DFJ305



18V

14.4V

12V_{MAX}DFJ304Z2XL
89,90 €DFJ304Z3XL
89,90 €DFJ304ZL
89,90 €DFJ304ZXL
89,90 €DFJ305ZL
99,90 €DFJ305ZXL
99,90 €DFJ305Z2XL
99,90 €

Pracovný čas (hod.)	s BL1860B Min. / Priemer / Max.:
	40 / 26,5 / 18,5
Prúdenie vzduchu	Turbo / Max. / Priemer / Min.:
	2,1 / 1,9 / 1,5 / 1,3 m ³ /min
Veľkosť	S / M / L / XL / 2XL / 3XL
Počet vreciek	5
Hmotnosť	DFJ304: 720 g DFJ305: 750 g

Dodávané bez adaptéra na akumulátor

Aku chladiaca bunda

DFJ405 / DFJ407 18 V, 14.4 V, 12 V max

Li-ion



DFJ407



DFJ405

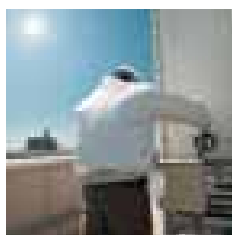

18V

14.4V

12V_{MAX}DFJ405ZL
109,90 €DFJ405ZXL
109,90 €DFJ405Z2XL
109,90 €DFJ407ZL
119,90 €DFJ407ZXL
119,90 €DFJ407Z2XL
119,90 €

Pracovný čas (hod.)	s BL1860B Min. / Priemer / Max.:
	40 / 26,5 / 18,5
Prúdenie vzduchu	Turbo / Max. / Priemer / Min.:
	2,1 / 1,9 / 1,5 / 1,3 m ³ /min
Veľkosť	S / M / L / XL / 2XL / 3XL
Počet vreciek	5
Hmotnosť	DFJ405: 700 g DFJ407: 720 g

Dodávané bez adaptéra na akumulátor

Aku chladiaca vesta

DFV210

NOVINKA

Li-ion



18V

14.4V

12V_{MAX}DFV210Z2XL
119,90 €DFV210ZL
119,90 €DFV210ZXL
119,90 €

Veľkosť	L / XL / 2XL
Dodávané bez adaptéra na akumulátor	

Aku vyhrievaná bunda

DCJ200 18 V, 14.4 V

Li-ion

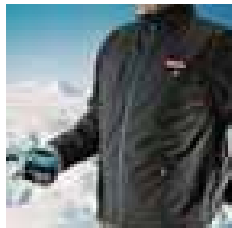

18V

14.4V

Pracovný čas (hod.)	DCJ200: s BL1830(B) Min. / Priemer / Max.: 17 / 9,5 / 5
Vyhrievacie zóny	Spolu / predná časť / zadná časť: 3 / 2 / 1
Stupne vyhrievania	Max. / Priemer / Min.
Veľkosť	S / M / L / XL / 2XL / 3XL
Počet vreciek	5
Hmotnosť	1,5 kg

DCJ200Z2XL
199,90 €DCJ200ZXL
199,90 €

Aku vyhrievaná bunda

DCJ205

NOVINKA

Li-ion

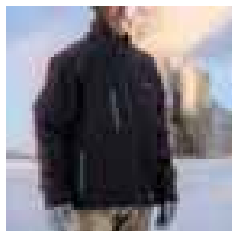

18V

14.4V

Vyhrievacie zóny	Spolu / predná časť / zadná časť: 3 / 2 / 1
Veľkosť	M / L / XL / 2XL / 3XL

DCJ205Z2XL
169,90 €DCJ205ZL
169,90 €DCJ205ZM
169,90 €DCJ205ZXL
169,90 €

Aku vyhrievaná bunda

DCJ206

NOVINKA

Li-ion

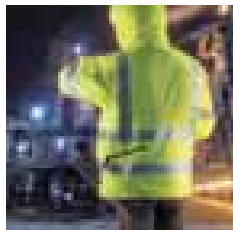

18V

14.4V

Vyhrievacie zóny Spolu / predná časť/ zadná časť: 3 / 2 / 1
Veľkosť M / L / XL / 2XL / 3XL

DCJ206Z2XL
199,90 €

DCJ206ZL
199,90 €

DCJ206ZM
199,90 €

DCJ206ZXL
199,90 €

Aku vyhrievaná bunda

CJ105

NOVINKA

Li-ion



12V_{MAX}

Vyhrievacie zóny Spolu / predná časť/ zadná časť: 3 / 2 / 1
Veľkosť M / L / XL / 2XL

CJ105DZ2XL
179,90 €

CJ105DZL
179,90 €

CJ105DZM
179,90 €

CJ105DZXL
179,90 €

Aku vyhrievaná bunda

CJ106

NOVINKA

Li-ion



12V_{MAX}

Vyhrievacie zóny Spolu / predná časť/ zadná časť: 3 / 2 / 1
Veľkosť M / L / XL / 2XL

CJ106DZ2XL
199,90 €

CJ106DZL
199,90 €

CJ106DZM
199,90 €

CJ106DZXL
199,90 €

Aku vyhrievaná vesta

DCV202 18 V, 14.4 V / CV101 12 V max

Li-ion



18V

14.4V

12V_{MAX}

Pracovný čas (hod.) DCV202: s BL1850(B) Min. / Priemer / Max.:
28 / 16 / 8
CV101D: s BL1041B Min. / Priemer / Max.: 14 / 7,5 / 4
CV100D: s BL1013 Min. / Priemer / Max.: 4,5 / 2,5 / 1,5
Spolu / predná časť/ zadná časť: 2 / 1 / 1
Max. / Priemer / Min.
S / M / L / XL / 2XL / 3XL
Vyhrievacie zóny 4
Stupne vyhrievania 4
Veľkosť DCV202: 0,81 – 1,2 kg
Hmotnosť CV101D: 700 g
CV100D: 640 g

DCV202ZL
139,90 €

DCV202ZXL
139,90 €

DCV202Z2XL
139,90 €

CV101DZ2XL
189,90 €

CV101DZL
189,90 €

CV101DZM
189,90 €

CV101DZXL
189,90 €

Aku pumpa

MP100

NOVINKA

Li-ion

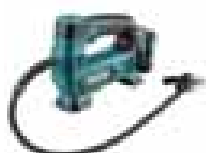

12V_{MAX}



Max. tlak vzduchu 830 kPa
Max. výkon 10 l/min
Hmotnosť 1,2 – 1,3 kg

MP100DZ
149,90 €

Aku rádio

DMR108 7,2-18 V / AC

Li-ion



7.2V

18V

12V_{MAX}
CXT LXT Bluetooth

Frekvencia	FM / AM: 87,5 – 108 MHz / 522 – 1.710 kHz
Veľkosť reproduktorov	Reproduktor: Ø89 mm×2
Max. výkon	18 V: 3,5 W×2
	14,4 V: 2,2 W×2
	10,8 V: 1,2 W×2
	7,2 V: 0,5 W×2
Bluetooth	Verzia: 4,0 Profil: A2DP / SCMS-T Podporovaný kódok: SBC Max. dosah: 10 m (33 ft)
Rozmery	262×163×431 mm
Hmotnosť	4,4 kg

DMR108
189,90 €

Aku rádio

DMR110 7,2-18 V / AC

Li-ion



7.2V

18V

CXT LXT DAB DAB+

Frekvencia	FM / DAB / DAB+: 87,5 – 108 MHz / / 174,928 – 239,200 MHz / 174,928 – 239,200 MHz
Veľkosť reproduktorov	Reproduktor: Ø76 mm×2
Max. výkon	18 V: 3,5 W×2
	14,4 V: 2,2 W×2
	10,8 V: 1,2 W×2
	7,2 V: 0,5 W×2
Rozmery	257×163×431 mm
Hmotnosť	4,1 – 4,6 kg

DMR110
179,90 €

Aku rádio

DMR107 7,2-18 V / AC

Li-ion



7.2V

18V

CXT LXT

Frekvencia	FM / AM: 87,5 – 108 MHz / 522 – 1.710 kHz
Veľkosť reproduktorov	Reproduktor: Ø76 mm×2
Max. výkon	18 V: 3,5 W×2
	14,4 V: 2,2 W×2
	10,8 V: 1,2 W×2
	7,2 V: 0,5 W×2
Rozmery	257×163×431 mm
Hmotnosť	4,1 kg

DMR107
149,90 €

Aku rádio

MR052

Li-ion



12V

CXT

Frekvencia	FM / AM: 87,5 – 108 MHz / 522 – 1.710 kHz
Pracovný čas (hod)	s BL1041B: 30
	s BL1021B: 15
	s BL1016: 11
Rozmery	169×73×74 mm
Hmotnosť	0,56 – 0,72 kg

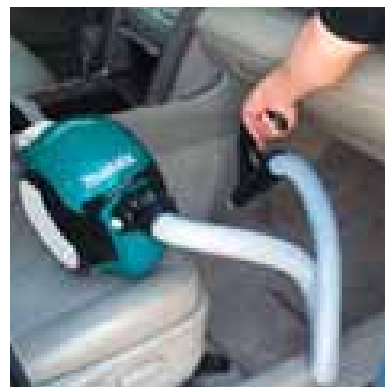
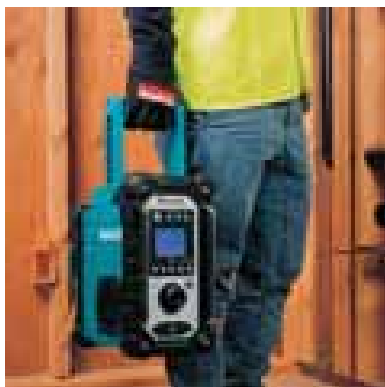
MR052
59,90 €

Aku reproduktor

DMR202

Li-ion



18V

14.4V

12V



Veľkosť reproduktorov	Reproduktor: Ø101,6 mm
Max. výkon	Výškový reproduktor: Ø36 mm 18 V: 10 W 14,4 V: 6 W 10,8 V: 3,5 W
Bluetooth	AC: 4 W Verzia: 4,0 Profil: A2DP / SCMS-T / AVRCP Podporovaný kódok: SBC Max. dosah: 10 m (33 ft)
Rozmery	211×206×286 mm
Hmotnosť	2,7 – 3,4 kg



DMR202
149,90 €

Aku vysávač

DVC860L /mokrú & suchú vysávanie/

Li-ion



18V



Objem zbernej nádoby	Prach: 8 / 6 L
Pracovný čas (min.)	s BL1850B x2: 65
Max. prúdenie vzduchu**	AC / DC: 3,6 / 2,1 m³/min
Vibrácie	2,5 m/s²
Úroveň akustického tlaku	75 dB(A)
Rozmery	366×334×368 mm
Hmotnosť	8,6 kg

Dodávané s hadicou a nadstavcami na vysávanie

DVC860LZ
549,90 €

Aku vysávač

DVC864 /mokrú & suchú vysávanie/

Li-ion



18V



Objem zbernej nádoby	Prach / Voda: 8 L
Pracovný čas (min.)	s BL1850B x2: 40
Max. prúdenie vzduchu**	2,1 m³/min
Vibrácie	2,5 m/s²
Úroveň akustického tlaku	70 dB(A)
Rozmery	366×334×368 mm
Hmotnosť	7,7 kg

Dodávané s hadicou

DVC864LZX
399,90 €

Aku vysávač

DVC750

NOVINKA

Li-ion



18V

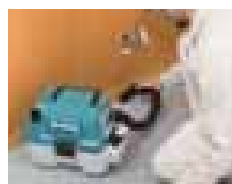

Objem zbernej nádoby	Prach / Voda: 7,5 / 4,5 L
Pracovný čas (min.)	s BL1850B Max 30 min, Min 60 min
Max. prúdenie vzduchu	MAX 1,6 m³/min, MIN 1,3 m³/min
Vibrácie	2,5 m/s²
Úroveň akustického tlaku	76 dB(A)
Rozmery	418×251×278
Hmotnosť	4,3 – 4,6 kg

Dodávané s hadicou a nadstavcami na vysávanie

DVC750LZX1
169,90 €

Aku chrbtový vysávač

DVC265

NOVINKA

Li-ion



18V



Objem zbernej nádoby	Prach / Voda: 1,5 L
Pracovný čas (min.)	s BL1860B Max 40 min, Min 75 min
Max. prúdenie vzduchu	2,0 m³/min,
Vibrácie	2,5 m/s²
Úroveň akustického tlaku	70 dB(A)
Rozmery	230×152×373
Hmotnosť	3,9 – 4,5 kg

Dodávané s hadicou

DVC265ZXU
349,90 €



Aku chrbtový vysávač

DVC261

NOVINKA

Li-ion



18V

BL MOTOR **XPT** **HEPA filter**
EXTREME PROTECTION TECHNOLOGY

Objem zbernej nádoby	Prach / Voda: 1,5 L
Pracovný čas (min.)	s BL1860B Max 40 min, High 75 min, Normal 140 min
Max. prúdenie vzduchu	2,0 m ³ /min,
Vibrácie	2,5 m/s ²
Úroveň akustického tlaku	70 dB(A)
Rozmery	230×152×373
Hmotnosť	3,8 – 4,5 kg

Dodávané s hadicou a nastavkami na vysávanie

DVC261ZX11
339,90 €

Aku robotický vysávač

DRC200

Li-ion



18V

BL MOTOR

Pracovný čas (min.)	s BL1850B x2: 200 s BL1830B x2: 120
Max. plocha	s BL1850B x2: 500 m ² s BL1830B x2: 300 m ²
Max. rýchlosť	0,3 m/sec
Objem zbernej nádoby	2,5 L
Rozmery	460×460×180 mm
Hmotnosť	7,8 kg

DRC200Z
999,90 €

Aku vysávač

DCL180 / DCL182

Li-ion



18V

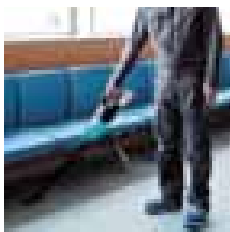

	DCL180	DCL182
Objem zbernej nádoby	650 mL	Zberné vrečko: 500 mL Papierové vrečko: 330 mL
Pracovný čas (min.)	s BL1830B: 20	s BL1850B (Max.): 33 s BL1850B (Min.): 66
Max. prúdenie vzduchu	1,4 m ³ /min	1,4 m ³ /min
Rozmery	999×114×152 mm	1.004×115×151 mm
Hmotnosť	1,2 kg	1,3 kg

DCL180Z
49,90 €DCL182Z
64,90 €

Aku vysávač

CL183D

Li-ion

1,5



18V

G séria



Objem zbernej nádoby	600 mL
Pracovný čas (min.)	24
Max. prúdenie vzduchu	1,3 m ³ /min
Rozmery	966×102×148 mm
Hmotnosť	1,1 kg

CL183DZ
46,90 €

Aku vysávač

CL106FD / CL107FD

Li-ion

12V_{MAX}

CL107FD



	CL106FD	CL107FD
Objem zbernej nádoby	600 mL	Zberné vrečko: 500 mL Papierové vrečko: 330 mL
Pracovný čas (min.)	s BL1041B: 42	Max: 20 / priemer: 24 / Min: 50
Max. prúdenie vzduchu	1,3 m ³ /min	1,4 m ³ /min
Rozmery	958×100×150 mm	960×112×150 mm
Hmotnosť	1,0 kg	1,1 kg

CL106FDWM
139,90 €CL106FDZ
49,90 €CL107FDZ
59,90 €



12V_{MAX}



Objem zbernej nádoby	600 mL
Pracovný čas (min.)	s BL1041B: Max/High/normal 20 / 24 / 50
Max. prúdenie vzduchu	1,3 m ³ /min
Rozmery	956×110×150 mm
Hmotnosť	1,0 – 1,2 kg

CL108FDWA
129,90 €

CL108FDZ
59,90 €



10.8V



CL104D



Objem zbernej nádoby	Zberné vrecko: 500 mL Papierové vrecko: 330 mL
Pracovný čas (min.)	Turbo / Max. / Min.: 10 / 15 / 30
Max. prúdenie vzduchu	1,3 m ³ /min
Rozmery	983×113×136 mm
Hmotnosť	1,1 kg

CL104DWY
89,90 €



7.2V



Objem zbernej nádoby	600 mL
Pracovný čas (min.)	8
Max. prúdenie vzduchu	1,2 m ³ /min
Rozmery	966×103×142 mm
Hmotnosť	0,81 kg

CL070DS
84,90 €



18V



Objem zbernej nádoby	250 mL s BL1860B (Max.): 35 s BL1860B (Min.): 77
Pracovný čas (min.)	
Max. prúdenie vzduchu	1,2 m ³ /min
Rozmery	352×189×252 mm
Hmotnosť	3,1 kg

Dodávané s hadicou a nadstavcami na vysávanie

DCL501Z
399,90 €

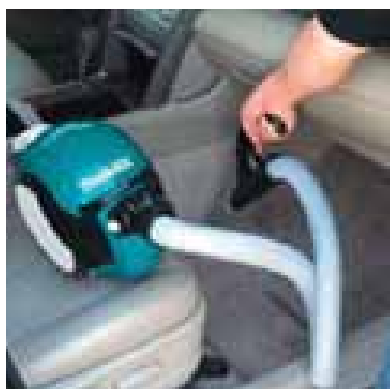

Aku skrutkovač

DF012D

Li-ion



7.2V



Max. vrtací výkon	Železo: 5 mm
	Drevo: 6 mm
Voľnoběžné otáčky	Max.: 650
	Min.: 200
Max. uťahovací moment	Tvrký / mäkký spoj: 5,6 / 3,6 N·m
Max. povoľovací moment	8,0 N·m
Vibrácie	Vŕtanie do železa: 2,5 m/s ²
Úroveň akustického tlaku	70 dB(A)
Rozmery	Rovná verzia: 218×44×142 mm
Rozmery (L×W)	Pistoľová verzia: 273×44 mm
Hmotnosť	0,53 kg

DF012DSE
169,90 €

Aku skrutkovač

TD022D

Li-ion



7.2V

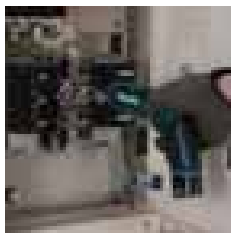

Max. výkon	Skrutka so šesťhrannou hlavou: M3 – M8
	Skrutka štandardná: M3 – M8
	Skrutka vysokopevnosťná: M3 – M6
Upínanie	1/4"
Voľnoběžné otáčky	0 – 2,450
Počet úderov za minútu	0 – 3,000
Max. uťahovací moment	25 N·m
Vibrácie	Upevňovacia skrutka: 7,0 m/s ²
Úroveň akustického tlaku	85 dB(A)
Úroveň akustického výkonu	96 dB(A)
Rozmery	Rovná verzia: 282×42×52 mm
	Pistoľová verzia: 227×42×142 mm
Hmotnosť	0,55 – 0,56 kg

TD022DSE
159,90 €

Aku skrutkovač

TD021D

Li-ion



7.2V



Max. uťahovací výkon	Skrutka so šesťhrannou hlavou: M3 – M8
	Skrutka štandardná: M3 – M8
	Skrutka vysokopevnosťná: M3 – M6
Upínanie	1/4"
Počet úderov za minútu	0 – 3,000ipm
Voľnoběžné otáčky / min ⁻¹	0 – 2,300rpm
Max. uťahovací moment	22N·m (195in.lbs)
Rozmery	Pistoľová verzia: 227×42×144 mm
	Rovná verzia: 282×42
Hmotnosť	0,54 kg

TD021DSE
149,90 €

Aku skrutkovač

DF001D

Li-ion

7.2V

Max. uťahovací výkon	Skrutky do dreva: ø3,8x32 mm
Voľnobežné otáčky	220
Max. uťahovací moment	Tvrdý / mäkký spoj: 4,0 / 3,0 N·m
Max. povoľovací moment	6,0 N·m
Vibrácie	2,5 m/s ²
Úroveň akustického tlaku	70 dB(A)
Nabíjací čas (hod.)	3 - 5
Rozmery	Rovná verzia: 287x47x51 mm
	Píštoľová verzia: 205x47x51 mm
Hmotnosť	0,36 kg

DF001DW
 59,90 €

Aku skrutkovač

DF457D 13 mm

Li-ion

18V

G séria



Max. vrtací výkon	Železo: 13 mm
	Drevo: 36 mm
Voľnobežné otáčky	Max.: 0 - 1.400
	Min.: 0 - 400
Max. uťahovací moment	Tvrdý / mäkký spoj: 42 / 24 N·m
Max. povoľovací moment	38 N·m
Rozmery	221x83x240 mm
Hmotnosť	1,7 kg

DF457DWE
 159,90 €

DF457DWLX1
 179,90 €

X1 - 11 dielna sada bitov

Aku skrutkovač s príklepom

HP457D 13 mm

Li-ion

18V







G séria



Max. vrtací výkon	Železo / Drevo / Murivo:
	13 / 36 / 13 mm
Počet úderov za minútu	Max. / Min.: 0 - 21.000 / 0 - 6.000
Voľnobežné otáčky	Max. / Min.: 0 - 1.400 / 0 - 400
Max. uťahovací moment	Tvrdý / mäkký spoj: 42 / 24 N·m
Max. povoľovací moment	38 N·m
Vibrácie	Vrtanie s príklepom: 7,0 m/s ²
	Vrtanie do železa: 2,5 m/s ²
Úroveň akustického tlaku	81 dB(A)
Úroveň akustického výkonu	92 dB(A)
Rozmery	239x83x240 mm
Hmotnosť	1,7 kg

HP457DWE
 169,90 €



14.4V Lithium-ion		DC18RC	DC18SD	DC18SE (Automotive)	DC24SA DC24SC
		 9.6V,12V 14.4V,18V	 9.6V,12V 14.4V,18V	 9.6V,12V 14.4V,18V	 9.6V,12V 14.4V,18V,24V
6.0 Ah	 BL1460A (197422-4)	Fast Charging 55 min.	130 min.	130 min.	75 min.
1.5 Ah	 BL1415NA (197282-4)	15 min.	30 min.	15 min.	20 min.



Akumulátorové náradie pre priemysel

Li-ion	Type	Model	Úťahovací model	Hmotnosť	Voľnobežné otáčky (RPM)																					
					0	100	200	300	400	500	600	700	800	900	1,000	1,100	1,200	1,300	1,400							
14.4V	Pistol	DFT023F	0.5-2	1.1 - 1.3	[Bar chart showing RPM range from ~400 to ~1300]																					
		DFT045F	1-4	1.1 - 1.3	[Bar chart showing RPM range from ~150 to ~900]																					
		DFT085F	3-8	1.3 - 1.8	[Bar chart showing RPM range from ~180 to ~900]																					
		DFT127F	5-12	1.3 - 1.8	[Bar chart showing RPM range from ~200 to ~600]																					
	Angle	DFL062F	1.5-6	1.6 - 1.9	[Square marker at ~450 RPM]																					
		DFL083F	2-8	1.7 - 2.1	[Bar chart showing RPM range from ~180 to ~700]																					
		DFL124F	5-12	1.7 - 1.9	[Square marker at ~400 RPM]																					
		DFL125F	5-12	1.7 - 2.1	[Bar chart showing RPM range from ~180 to ~700]																					
		DFL203F	8-20	1.7 - 1.9	[Square marker at ~200 RPM]																					
		DFL204F	8-20	1.7 - 2.1	[Bar chart showing RPM range from ~150 to ~450]																					
		DFL302F	16-30	2.0 - 2.3	[Bar chart showing RPM range from ~100 to ~200]																					
		DFL403F	25-40	2.0 - 2.3	[Bar chart showing RPM range from ~80 to ~180]																					
		Torque Tracer	Pistol	DFT041R	1-4	1.3 - 1.8	[Square marker at ~800 RPM]																			
				DFT082R	4-8	1.3 - 1.8	[Square marker at ~900 RPM]																			
Torque Tracer	Pistol	DFT124R	6-12	1.3 - 1.8	[Square marker at ~600 RPM]																					
		DFL201R	10-20	1.5 - 1.9	[Square marker at ~400 RPM]																					
	Angle	DFL301R	16-30	1.8 - 2.2	[Square marker at ~250 RPM]																					
		DFL402R	25-40	1.8 - 2.2	[Square marker at ~180 RPM]																					
18V	Angle	DFL650F	25-65	2.4 - 2.9	[Bar chart showing RPM range from ~100 to ~200]																					
		DFL651F	25-65	2.5 - 2.9	[Bar chart showing RPM range from ~100 to ~200]																					



Aku skrutkovač

DFT023F



14.4V



Upínanie	1/4"
Voľnobežné otáčky / min ⁻¹	400 – 1,300
Uťahovací moment	Hard / Soft: 0,5 – 2 / 0,5 – 2 N·m
Vibrácie	Uťahovanie bez priklepu: 2,5 m/s ²
Úroveň akustického tlaku	70 dB(A)
Rozmery	159×72×232 mm
Hmotnosť	1,1 – 1,3 kg

DFT023FMZ
649,90 €

Aku skrutkovač

DFT045F



14.4V



Upínanie	1/4"
Voľnobežné otáčky / min ⁻¹	150 – 900
Uťahovací moment	Tvrдый spoj / Mäkky spoj: 1 – 4 / 1 – 4 N·m
Vibrácie	Uťahovanie bez priklepu: 2,5 m/s ²
Úroveň akustického tlaku	70 dB(A)
Rozmery	159×72×232 mm
Hmotnosť	1,1 – 1,3 kg

DFT045FZ
649,90 €

Aku skrutkovač

DFT085F



14.4V



Upínanie	1/4"
Voľnobežné otáčky / min ⁻¹	150 – 900
Uťahovací moment	Tvrдый spoj / Mäkky spoj: 3 – 8 / 3 – 8 N·m (27 – 71 / 27 – 71 in.lbs.)
Vibrácie	Uťahovanie bez priklepu: 2,5 m/s ²
Úroveň akustického tlaku	70 dB(A)
Rozmery	190×72×237 mm
Hmotnosť	1,3 – 1,8 kg

DFT085FMZ
679,90 €

Aku skrutkovač

DFT127F



14.4V



Upínanie	1/4"
Voľnobežné otáčky / min ⁻¹	100 – 600
Uťahovací moment	Tvrдый spoj / Mäkky spoj: 5 – 12 / 5 – 12 N·m
Vibrácie	Uťahovanie bez priklepu: 2,5 m/s ²
Úroveň akustického tlaku	70 dB(A)
Rozmery	190×72×237 mm
Hmotnosť	1,3 – 1,8 kg

DFT127FZ
679,90 €

Aku skrutkovač

DFL302F



14.4V



Upínanie	3/8"
Voľnobežné otáčky / min ⁻¹	70 – 230
Uťahovací moment	Tvrдый spoj / Mäkky spoj: 16 – 30 / 16 – 30 N·m
Rozmery	s BL1415N: 501×74×98 mm s BL1430(B) / BL1440 / BL1450 / BL1460B: 518×74×98 mm
Hmotnosť	2,0 – 2,3 kg

DFL302FZ
1 599,00 €

Aku skrutkovač

DFL403F



14.4V

BL
 MOTOR

Upínanie	3/8"
Voľnobežné otáčky / min ⁻¹	50 – 220
Uťahovací moment	Tvrдый spoj / Mäkky spoj: 25 – 40 / 25 – 40 N·m
Rozmery	s BL1415N: 501×74×98 mm s BL1430(B) / BL1440 / BL1450 / BL1460B: 518×74×98 mm
Hmotnosť	2.0 – 2.3 kg

DFL403FZ
 1 999,00 €

Aku skrutkovač

DFL082F



14.4V



Upínanie	3/8"
Voľnobežné otáčky / min ⁻¹	700
Uťahovací moment	Tvrдый spoj / Mäkky spoj: 2 – 8 / 2 – 8 N·m
Vibrácie	Uťahovanie bez priklepu: 2,5 m/s ²
Úroveň akustického tlaku	70 dB(A)
Rozmery	405×74×98 mm
Hmotnosť	1,5 – 1,9 kg

DFL082FZ
 629,90 €

Aku skrutkovač

DFL083

NOVINKA



14.4V

BL
 MOTOR

Upínanie	3/8"
Voľnobežné otáčky / min ⁻¹	150 – 700
Uťahovací moment	Tvrдый spoj / Mäkky spoj: 1 – 2 – 8 / 2 – 8 N·m
Vibrácie	Uťahovanie bez priklepu: 2,5 m/s ²
Úroveň akustického tlaku	70 dB(A)
Rozmery	480×74×98 mm
Hmotnosť	1,7 – 2,1 kg

DFL083FZ
 879,90 €

Aku skrutkovač

DFL201



14.4V

BL
 MOTOR

Upínanie	3/8"
Voľnobežné otáčky / min ⁻¹	360
Uťahovací moment	Tvrдый spoj / Mäkky spoj: 8 – 20 / 8 – 20 N·m
Vibrácie	Uťahovanie bez priklepu: 2,5 m/s ²
Úroveň akustického tlaku	72 dB(A)
Rozmery	429×72×98 mm
Hmotnosť	1,5 – 2,1 kg

DFL201FZ
 1 499,00 €

Aku skrutkovač

DFL202

NOVINKA



14.4V



Upínanie	3/8"
Voľnobežné otáčky / min ⁻¹	220
Uťahovací moment	Tvrдый spoj / Mäkky spoj: 8 – 20 / 8 – 20 N·m
Vibrácie	Uťahovanie bez priklepu: 2,5 m/s ²
Úroveň akustického tlaku	70 dB(A)
Rozmery	405×74×98 mm
Hmotnosť	1,5 – 1,9 kg

DFL202FZ
 1 499,00 €



14.4V



Upínanie	3/8"
Voľnobežné otáčky / min ⁻¹	100 – 440
Uťahovací moment	Tvrдый spoj / Mäkky spoj: 8 – 20 / 8 – 20 N·m
Vibrácie	Uťahovanie bez priklepu: 2,5 m/s ²
Úroveň akustického tlaku	70 dB(A)
Rozmery	480×74×98 mm
Hmotnosť	1,7 – 2,1 kg

DFL204FZ
1 599,00 €



14.4V



Upínanie	3/8"
Voľnobežné otáčky / min ⁻¹	260
Uťahovací moment	Tvrдый spoj / Mäkky spoj: 16 – 30 / 16 – 30 N·m
Vibrácie	Uťahovanie bez priklepu: 2,5 m/s ²
Úroveň akustického tlaku	74 dB(A)
Rozmery	477×72×98 mm
Hmotnosť	1,7 – 2,1 kg

DFL301FZ
1 899,00 €



14.4V



Upínanie	3/8"
Voľnobežné otáčky / min ⁻¹	200
Uťahovací moment	Tvrдый spoj / Mäkky spoj: 25 – 40 / 25 – 40 N·m
Vibrácie	Uťahovanie bez priklepu: 2,5 m/s ²
Úroveň akustického tlaku	72 dB(A)
Rozmery	477×72×98 mm
Hmotnosť	1,7 – 2,1 kg

DFL402FZ
1 999,00 €



18V



Upínanie	3/8"
Voľnobežné otáčky / min ⁻¹	80 – 200
Uťahovací moment	Tvrдый spoj / Mäkky spoj: 25 – 65 / 25 – 65 N·m
Vibrácie	Uťahovanie bez priklepu: 2,5 m/s ²
Úroveň akustického tlaku	72 dB(A)
Rozmery	600×75×116 mm
Hmotnosť	2,5 – 2,9 kg

DFL651FZ
1 799,00 €



12Vmax



18V





18V series



18V / 12V max series



12V max series

USB



USB



USB



USB



USB



USB



USB















USB



▣ VŔTANIE / UŤAHOVANIE



-  Dvojitá izolácia
-  Nastavenie otáčok
-  Brzda
-  Spätný chod
-  Dvojrýchlostná prevodovka
-  Trojrýchlostná prevodovka
-  El. nastavenie otáčok /2 rýchlosti/
-  Rýchloskľučovadlo
-  Nastavenie momentu /6 stupňov/
-  Obmedzovač momentu
-  Obmedzovač rozbehového prúdu
-  Zabudované osvetlenie
-  Prepravný kufr





Prikon	230W
Max. výkon	Skrutka so šesťhrannou hlavou: M4 – M8 Skrutka štandardná: M5 – M14 Skrutka vysokopevnosť: M5 – M10
Upínanie	1/4"
Počet úderov za minútu	0 – 3.200
Voľnobežné otáčky	0 – 3.600
Max. ťahovací moment	100 N·m
Rozmery	184×67×192 mm
Hmotnosť	0,99 kg
Dĺžka privodného kábla	2,5 m

TD0101F
99,90 €



Prikon	370W
Max. výkon	Železo: 6,5 mm Drevo: 15 mm
Voľnobežné otáčky	0 – 4.200
Rozmery	209×64×175 mm
Hmotnosť	1,0 kg
Dĺžka privodného kábla	2,0 m

DP2010
55,90 €



Prikon	530W
Max. výkon	Železo: 10 mm Drevo: 25 mm
Voľnobežné otáčky	0 – 2.500
Celková dĺžka	261 mm
Hmotnosť	1,5 kg
Dĺžka privodného kábla	2,5 m

6408
119,90 €



6413

	6413	6412
Prikon	450W	450W
Max. výkon	Železo: 10 mm Drevo: 25 mm	Železo: 10 mm Drevo: 25 mm
Voľnobežné otáčky	0 – 3.400	0 – 3.400
Rozmery	234×64×183 mm	228×64×183 mm
Hmotnosť	1,3 kg	1,3 kg
Dĺžka privodného kábla	2,0 m	2,0 m

6413
69,90 €

6412
59,90 €

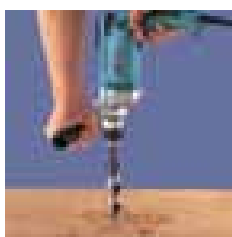

Prikon	750W
Max. výkon	Železo: 13 mm Drevo: 38 mm
Voľnobežné otáčky	0 – 700
Celková dĺžka	308 mm
Hmotnosť	2,5 kg
Dĺžka privodného kábla	2,5 m

DP4003
259,90 €

Vrtačka /dvojrychlostná/

DP4011 / DP4010 13 mm

419



DP4011

Príkon	720W
Max. výkon	Železo max.: 8 mm
	Železo min.: 13 mm
	Drevo max.: 25 mm
	Drevo min.: 40 mm
Voľnoběžné otáčky	Max.: 0 - 2.900
	Min.: 0 - 1.200
Rozmery	347x70x220 mm
Hmotnosť	2,3 kg
Dĺžka privodného kábla	2,5 m

DP4011
139,90 €DP4010
119,90 €

Vrtačka

DP4700 13 mm

64



Príkon	510W
Max. výkon	Železo: 13 mm
	Drevo: 36 mm
Voľnoběžné otáčky	0 - 550
Celková dĺžka	275 mm
Hmotnosť	2,2 kg
Dĺžka privodného kábla	2,5 m

DP4700
219,90 €

Vrtačka

DS4012 13 mm

411



Príkon	750W
Max. výkon	Železo: 13 mm
	Drevo: 36 mm
Voľnoběžné otáčky	0 - 600
Rozmery	340x83x390 mm
Hmotnosť	2,8 kg
Dĺžka privodného kábla	2,5 m

DS4012
189,90 €

Uhlová vrtačka

DA3010F 10 mm

419

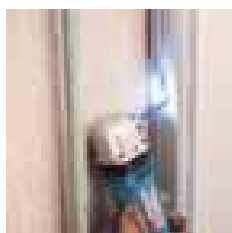
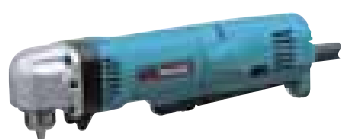

Príkon	450W
Max. výkon	Železo: 10 mm
	Drevo: 25 mm
Voľnoběžné otáčky	0 - 2.400
Celková dĺžka	270 mm
Hmotnosť	1,6 kg
Dĺžka privodného kábla	2,5 m

DA3010F
249,90 €

Uhlová vrtačka

DA4000LR 13 mm

303

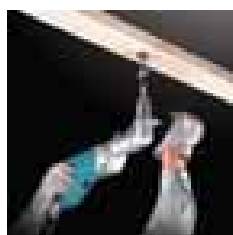

Príkon	710W
Max. výkon	Železo: 13 mm
Voľnoběžné otáčky	Max.: 0 - 900
	Min.: 0 - 400
Celková dĺžka	413 mm
Hmotnosť	4 kg
Dĺžka privodného kábla	2,5 m

DA4000LR
439,90 €

Dimantová vrtačka

DBM230 /mokré vrtanie/

EE7332022S 

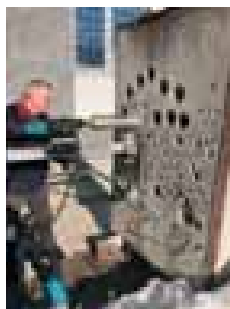

Prikon	2.500W
Max. výkon	Betón (s diamantovou korunkou): 230 mm
Voľnobežné otáčky	3: 1.700 2: 1.040 1: 390
Hmotnosť	37,5 kg

DBM230
1 399,00 €

Dimantová vrtačka

DBM131 /mokré vrtanie/ / DBM130 /suché vrtanie/

EE80600306 



	DBM131	DBM130
Prikon	1.700W	1.700W
Max. výkon		
(s diamantovou korunkou) Max.:	Betón: 70 mm	Betón: 70 mm
(s diamantovou korunkou) Min.:	Betón: 132 mm	Betón: 132 mm
Upínanie nástroja	(Vreteno /oska/) : M18	(Vreteno /oska/) : M18
Voľnobežné otáčky	Max.: 0 - 2.300 Min.: 0-1.100	Max.: 0 - 3.000 Min.: 0-1.500
Hmotnosť	6,3 kg	5,5 kg

DBM131
799,90 €

DBM130
599,90 €

Dimantová vrtačka

DBM080 82 mm /suché vrtanie/

EE80600306 



Prikon	1.300W
Max. výkon	Betón (s diamantovou korunkou): 82 mm
Upínanie nástroja	(Vreteno /oska/) : M18
Voľnobežné otáčky	0 - 3.400
Hmotnosť	3,4 kg

DBM080
399,90 €

Miešadlo

UT1600 / UT1401

EE7132A22S  EE7332022S 



	UT1600	UT1401
Prikon	1.800W	1.300W
Max. hmotnosť hmoty	90 kg	60 kg
Max. priemer miešadla	180 mm	140 mm
Voľnobežné otáčky	Max. / Min.: 0 - 970 / 0 - 440	Max. / Min.: 0 - 730 / 0 - 400
Rozmery	430×180×349 mm	430×180×349 mm
Hmotnosť	7,1 kg	5,5 kg
Dĺžka privodného kábla	3,2 m	3,2 m

UT1600
429,90 €

UT1401
349,90 €

Miešadlo

UT1400 140 mm

EE7132A22S 

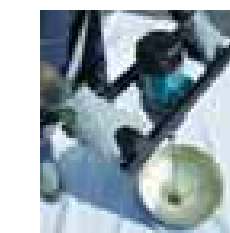



Prikon	1.300W
Max. hmotnosť hmoty	50 kg
Max. priemer miešadla	140 mm
Voľnobežné otáčky	0 - 900
Rozmery	430×180×305 mm
Hmotnosť	5,2 kg
Dĺžka privodného kábla	3,2 m

UT1400
299,90 €

Miešadlo

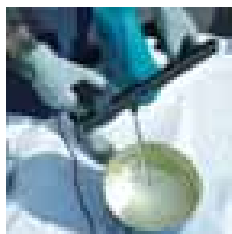
UT1200 120 mm

EE77018225 

Príkon	960W
Max. hmotnosť hmoty	40 kg
Max. priemer miešadla	120 mm
Voľnobežné otáčky	0 – 590
Rozmery	345×180×295 mm
Hmotnosť	3,2 kg
Dĺžka privodného kábla	3,2 m



UT1200
179,90 €

Miešadlo

UT2204 / UT1305

303 

	UT2204	UT1305
Príkon	850W	850W
Max. priemer miešadla	220 mm	165 mm
Voľnobežné otáčky	550	1.300
Upínanie nástroja	M12 alebo M14	M12
Rozmery	929×89×152 mm	942×87×152 mm
Hmotnosť	2,7 kg	2,6 kg
Dĺžka privodného kábla	2,5 m	2,5 m



UT2204
239,90 €

UT1305
219,90 €

Skrutkovač na sadrokartón

FS2300

419 

Príkon	570W
Max. výkon	Sadrokartónové skrutky: 5 mm Samozávrtné skrutky: 6 mm
Upínanie	1/4"
Voľnobežné otáčky	0 – 2.500
Vibrácie	2,5 m/s ²
Úroveň akustického tlaku	83 dB(A)
Úroveň akustického výkonu	94 dB(A)
Rozmery	290×70×207 mm
Hmotnosť	1,6 kg
Dĺžka privodného kábla	2,5 m



FS2300
149,90 €

Skrutkovač na sadrokartón

FS4000

419 

Príkon	570W
Max. výkon	Sadrokartónové skrutky: 5 mm Samozávrtné skrutky: 6 mm
Upínanie	1/4"
Voľnobežné otáčky	0 – 4.000
Vibrácie	2,5 m/s ²
Úroveň akustického tlaku	82 dB(A)
Úroveň akustického výkonu	93 dB(A)
Rozmery	269×65×207 mm
Hmotnosť	1,3 kg
Dĺžka privodného kábla	2,5 m



FS4000
119,90 €

Skrutkovač na sadrokartón

FS4300

419 

Príkon	570W
Max. výkon	Sadrokartónové skrutky: 5 mm Samozávrtné skrutky: 6 mm
Upínanie	1/4"
Voľnobežné otáčky	0 – 4.000
Vibrácie	2,5 m/s ²
Úroveň akustického tlaku	82 dB(A)
Úroveň akustického výkonu	93 dB(A)
Rozmery	279×65×207 mm
Hmotnosť	1,4 kg
Dĺžka privodného kábla	2,5 m



FS4300
139,90 €

FS4300X2
159,90 €

Skrutkovač na sadrokartón
FS6300R

419

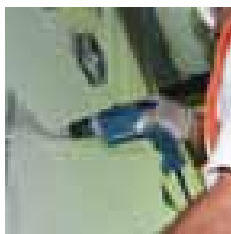

Prikon	570W
Max. výkon	Sadrokartónové skrutky: 4 mm
Upínanie	1/4"
Voľnobežné otáčky	0 – 6.000
Rozmery	279×65×207 mm
Hmotnosť	1,4 kg
Dĺžka privodného kábla	4,0 m

FS6300R
139,90 €
Skrutkovač
FS2700

419



Prikon	570W
Max. výkon	Samozávrtné skrutky: 6 mm
	Skrutka so šesťhrannou hlavou: 8 mm
	Skrutky do dreva: 6,2 mm
Upínanie	1/4"
Voľnobežné otáčky	0 – 2.500
Vibrácie	2,5 m/s ²
Úroveň akustického tlaku	83 dB(A)
Úroveň akustického výkonu	94 dB(A)
Rozmery	301×70×207 mm
Hmotnosť	1,8 kg
Dĺžka privodného kábla	2,5 m

FS2700
149,90 €
Rázový uťahovač
TW0350 1/2"

325



Prikon	400W
Max. uťahovací výkon	Skrutka Standardná: M12 – M22
	Skrutka vysokopevnostná: M12 – M16
Uchytenie nástroja	1/2"
Voľnobežné otáčky	2.000
Počet úderov za minútu	2.000
Max. uťahovací moment	350 N·m
Vibrácie	11,5 m/s ²
Úroveň akustického tlaku	93 dB(A)
Úroveň akustického výkonu	104 dB(A)
Rozmery	283×87×233 mm
Hmotnosť	3 kg
Dĺžka privodného kábla	2,5 m

TW0350
299,90 €
Rázový uťahovač
TW0200 1/2"

415

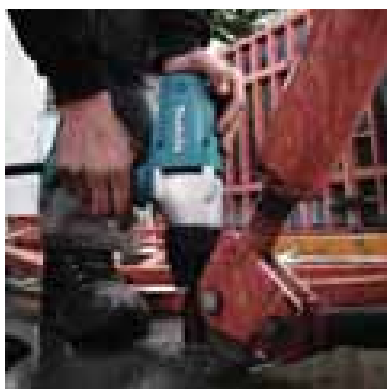

Prikon	380W
Max. uťahovací výkon	Skrutka štandardná: M10 – M16
	Skrutka vysokopevnostná: M10 – M12
Uchytenie nástroja	1/2"
Voľnobežné otáčky	0 – 2.200
Počet úderov za minútu	0 – 2.200
Max. uťahovací moment	200 N·m
Vibrácie	8,5 m/s ²
Úroveň akustického tlaku	93 dB(A)
Úroveň akustického výkonu	104 dB(A)
Rozmery	251×72×220 mm
Hmotnosť	2,1 kg
Dĺžka privodného kábla	2,5 m

TW0200
249,90 €

Rázový uťahovač

6953 1/2"

411 

Príkon	280W
Max. uťahovací výkon	Skrutka štandardná: M10 - M16 Skrutka vysokopevnostná: M8 - M12
Uchytenie nástroja	1/2"
Počet úderov za minútu	0 - 3.000
Voľnobežné otáčky	0 - 3.000
Max. uťahovací moment	150 N·m
Vibrácie	8,5 m/s ²
Úroveň akustického tlaku	96 dB(A)
Úroveň akustického výkonu	107 dB(A)
Celková dĺžka	233 mm
Hmotnosť	1,5 kg
Dĺžka privodného kábla	2,5 m

6953
229,90 €

Rázový uťahovač

6906 3/4"

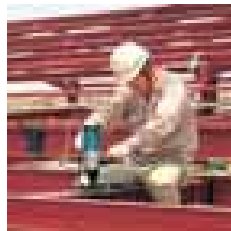
100 

Príkon	850W
Max. výkon	Skrutka štandardná: M16 - M22 Skrutka vysokopevnostná: M16 - M20
Uchytenie nástroja	3/4"
Voľnobežné otáčky	1.700
Počet úderov za minútu	1.600
Max. uťahovací moment	588 N·m
Vibrácie	16,5 m/s ²
Úroveň akustického tlaku	98 dB(A)
Úroveň akustického výkonu	109 dB(A)
Celková dĺžka	327 mm
Hmotnosť	5,6 kg
Dĺžka privodného kábla	2,5 m

6906
599,90 €

Rázový uťahovač

TW1000 1"

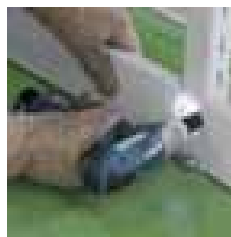



















153 

Príkon	1.200W
Max. uťahovací výkon	Skrutka štandardná: M24 - M30 Skrutka vysokopevnostná: M22 - M24
Uchytenie nástroja	1"
Voľnobežné otáčky	1.400
Počet úderov za minútu	1.500
Max. uťahovací moment	1.000 N·m
Vibrácie	17,5 m/s ²
Úroveň akustického tlaku	103 dB(A)
Úroveň akustického výkonu	114 dB(A)
Rozmery	382x110x290 mm
Hmotnosť	8,8 kg
Dĺžka privodného kábla	2,5 m

TW1000
799,90 €



▣ VRTANIE S PRÍKLEPOM / BÚRANIE

- 
-  Dvojitá izolácia
 -  Nastavenie otáčok
 -  Spätný chod
 -  Rýchlosklučovadlo
 -  Zabudované osvetlenie
 -  Dvojrýchlostná prevodovka
 -  Obmedzovač momentu
 -  Konštantné otáčky
 -  Obmedzovač rozbehového prúdu
 -  SDS Plus
 -  SDS Max
 -  17 mm Hex
 -  19 mm Hex
 -  21 mm Hex
 -  28,6 mm Hex
 -  30 mm Hex
 -  Klinový hriadeľ
 -  Odsávanie prachu
 -  Prepravný kufor

Vrtačka s príklepom

HP1631K / HP1630K 16 mm

85 

HP1631K

Príkon	710W
Max. výkon	Betón: 16 mm
	Železo: 13 mm
	Drevo: 30 mm
Voľnobežné otáčky	0 – 3.200
Počet úderov za minútu	0 – 48.000
Vibrácie	Vŕtanie s príklepom: 17,0 m/s ²
	Vŕtanie do železa: 2,5 m/s ²
Úroveň akustického tlaku	97 dB(A)
Úroveň akustického výkonu	108 dB(A)
Rozmery	296×75×204 mm
Hmotnosť	HP1631 : 2,0 kg
	HP1630 : 2,1 kg
Dĺžka privodného kábla	2,0 m

HP1631K
99,90 €
HP1630K
89,90 €

Vrtačka s príklepom

HP1641 16 mm

419 

Príkon	680W
Max. výkon	Betón: 16 mm
	Železo: 13 mm
	Drevo: 30 mm
Voľnobežné otáčky	0 – 2.800
Počet úderov za minútu	0 – 44.800
Vibrácie	Vŕtanie s príklepom: 19 m/s ²
	Vŕtanie do železa: 2,5 m/s ²
Úroveň akustického tlaku	92 dB(A)
Úroveň akustického výkonu	103 dB(A)
Rozmery	303×72×222 mm
Hmotnosť	2,0 kg
Dĺžka privodného kábla	2,0 m

HP1641K1X
114,90 €

1X – 9 dielna sada vrtákov

Vrtačka s príklepom

HP1640 / HP1640K 16 mm

419 

Príkon	680W
Max. výkon	Betón: 16 mm
	Železo: 13 mm
	Drevo: 30 mm
Voľnobežné otáčky	0 – 2.800
Počet úderov za minútu	0 – 44.800
Vibrácie	Vŕtanie s príklepom: 19 m/s ²
	Vŕtanie do železa: 2,5 m/s ²
Úroveň akustického tlaku	92 dB(A)
Úroveň akustického výkonu	103 dB(A)
Rozmery	303×72×222 mm
Hmotnosť	2,0 kg
Dĺžka privodného kábla	2,0 m

HP1640
79,90 €
HP1640K
89,90 €

Dvojrychlostná vrtačka s príklepom

HP2071J 20 mm

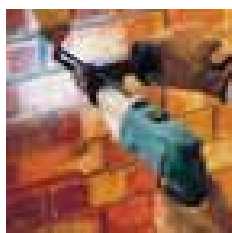
419 

Príkon	1.010W
Max. výkon	Betón: 20 mm
	Železo max.: 8 mm
	Železo min.: 16 mm
	Drevo max.: 25 mm
	Drevo min.: 40 mm
Počet úderov za minútu	Max.: 0 – 58.000
	Min.: 0 – 24.000
Voľnobežné otáčky	Max.: 0 – 2.900
	Min.: 0 – 1.200
Celková dĺžka	362 mm
Hmotnosť	2,6 kg
Dĺžka privodného kábla	2,5 m

HP2071J
199,90 €

Dvojrychlostná vrtačka s príklepom

HP2070J 20 mm

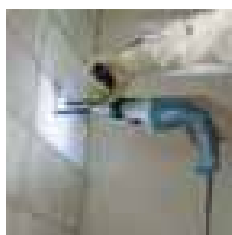
419 

Príkon	1.010W
Max. výkon	Betón: 20 mm
	Železo max.: 8 mm
	Železo min.: 16 mm
	Drevo max.: 25 mm
	Drevo min.: 40 mm
Počet úderov za minútu	Max.: 0 – 58.000
	Min.: 0 – 24.000
Voľnobežné otáčky	Max.: 0 – 2.900
	Min.: 0 – 1.200
Celková dĺžka	364 mm
Hmotnosť	2,6 kg
Dĺžka privodného kábla	2,5 m

HP2070J
189,90 €

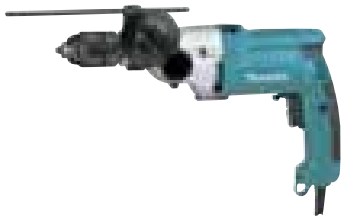

Prikon	720W
Max. výkon	Betón: 20 mm Železo max.: 8 mm Železo min.: 13 mm Drevo max.: 25 mm Drevo min.: 40 mm
Počet úderov za minútu	Max.: 0 – 58.000 Min.: 0 – 24.000
Voľnobežné otáčky	Max.: 0 – 2.900 Min.: 0 – 1.200
Celková dĺžka	360 mm
Hmotnosť	2,5 kg
Dĺžka privodného kábla	2,5 m

HP2051HJ
159,90 €

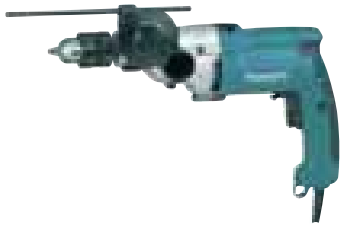

Prikon	720W
Max. výkon	Betón: 20 mm Železo max.: 8 mm Železo min.: 13 mm Drevo max.: 25 mm Drevo min.: 40 mm
Počet úderov za minútu	Max.: 0 – 58.000 Min.: 0 – 24.000
Voľnobežné otáčky	Max.: 0 – 2.900 Min.: 0 – 1.200
Celková dĺžka	362 mm
Hmotnosť	2,5 kg
Dĺžka privodného kábla	2,5 m

HP2050HJ
149,90 €



Prikon	470W
Sila príklepu	EPTA-Procedure 05/2009: 1,6 J
Max. výkon	Betón: 18 mm Vŕtacia korunka: 35 mm Diamantová vŕtacia korunka: 65 mm Železo: 13 mm Drevo: 24 mm
Počet úderov / min ⁻¹	0 – 4.800
Voľnobežné otáčky	0 – 2.100
Úroveň akustického tlaku	87 dB(A)
Úroveň akustického výkonu	98 dB(A)
Vibrácie	Vŕtanie s príklepom: 10,0 m/s ²
Rozmery	285×75×208 mm
Hmotnosť	2,0 – 2,4 kg
Dĺžka privodného kábla	2,5 m

HR1840
119,90 €

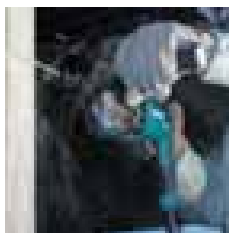

Prikon	720W
Sila príklepu	EPTA-Procedure 05/2009: 2,3 J
Max. výkon	Betón: 23 mm Železo: 13 mm Drevo: 32 mm
Počet úderov / min ⁻¹	0 – 4.600
Voľnobežné otáčky	0 – 1.200
Úroveň akustického tlaku	90 dB(A)
Úroveň akustického výkonu	101 dB(A)
Vibrácie	Vŕtanie s príklepom: 15,5 m/s ²
Rozmery	356×77×209 mm
Hmotnosť	2,7 – 3,1 kg
Dĺžka privodného kábla	2,5 m

HR2300
149,90 €



Rýchlosklučovadlo



Prikon	780W
Sila príklepu	EPTA-Procedure 05/2009: 2,4 J
Max. výkon	Betón: 24 mm Vŕtacia korunka: 54 mm Železo: 13 mm Drevo: 32 mm
Počet úderov / min ⁻¹	0 – 4.500
Voľnobežné otáčky	0 – 1.100
Úroveň akustického tlaku	90 dB(A)
Úroveň akustického výkonu	101 dB(A)
Vibrácie	Vŕtanie s príklepom: 15,5 m/s ² Vŕtanie do železa: 4,5 m/s ²
Rozmery	394×84×214 mm
Hmotnosť	3,0 – 3,3 kg
Dĺžka privodného kábla	4,0 m

HR2470T
229,90 €

Kombinované kladivo

HR2470 24 mm, SDS-PLUS

325 

Prikon	780W
Síla príklepu	EPTA-Procedure 05/2009: 2,4 J
Max. výkon	Betón: 24 mm
	Vřtacia korunka: 54 mm
	Železo: 13 mm
	Drevo: 32 mm
Počet úderov / min ⁻¹	0 - 4.500
Voľnobežné otáčky	0 - 1.100
Úroveň akustického tlaku	90 dB(A)
Úroveň akustického výkonu	101 dB(A)
Vibrácie - vrtanie	s príklepom: 15,5 m/s ² / do železa: 4,5 m/s ²
Rozmery	370x84x214 mm
Hmotnosť	2,9 - 3,3 kg
Dĺžka privodného kábla	4,0 m

HR2470
159,90 €

HR2470BX40
169,90 €

B - čierne prevedenie stroja; X40 - 5 ks vrtákov SDS Plus

Kombinované kladivo

HR2641 26 mm, SDS-PLUS

419 

Prikon	800W
Síla príklepu	EPTA-Procedure 05/2009: 2,4 J
Max. výkon	Betón: 26 mm
	Železo: 13 mm
	Drevo: 32 mm
Počet úderov / min ⁻¹	0 - 4.500
Voľnobežné otáčky	0 - 1.100
Úroveň akustického tlaku	90 dB(A)
Úroveň akustického výkonu	101 dB(A)
Vibrácie	Vrtanie s príklepom: 11,5 m/s ²
	Sekanie s rukoväťou: 9,0 m/s ²
	Vrtanie do železa: 2,5 m/s ²
Rozmery	422x76x156 mm
Hmotnosť	3,1 - 3,5 kg
Dĺžka privodného kábla	2,5 m

HR2641
179,90 €

Kombinované kladivo

HR2631FT 26 mm, SDS-PLUS

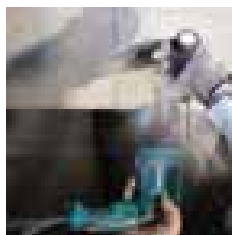
325 

Prikon	800W
Síla príklepu	EPTA-Procedure 05/2009: 2,4 J
Max. výkon	Betón: 26 mm
	Vřtacia korunka: 68 mm
	Diamantová vřtacia korunka: 80 mm
	Železo: 13 mm
	Drevo: 32 mm
Počet úderov / min ⁻¹	0 - 4.600
Voľnobežné otáčky	0 - 1.200
Úroveň akustického tlaku	90 dB(A)
Úroveň akustického výkonu	101 dB(A)
Vibrácie	Vrtanie s príklepom: 11,5 m/s ²
Rozmery	385x77x209 mm
Hmotnosť	3,1 - 3,6 kg
Dĺžka privodného kábla	2,5 m

HR2631FT
239,90 €

Kombinované kladivo

HR2631F 26 mm, SDS-PLUS

325 

Prikon	800W
Síla príklepu	EPTA-Procedure 05/2009: 2,4 J
Max. výkon	Betón: 26 mm
	Vřtacia korunka: 68 mm
	Diamantová vřtacia korunka: 80 mm
	Železo: 13 mm
	Drevo: 32 mm
Počet úderov / min ⁻¹	0 - 4.600
Voľnobežné otáčky	0 - 1.200
Úroveň akustického tlaku	90 dB(A)
Úroveň akustického výkonu	101 dB(A)
Vibrácie	Vrtanie s príklepom: 12,0 m/s ²
Rozmery	361x77x209 mm
Hmotnosť	2,9 - 3,4 kg
Dĺžka privodného kábla	2,5 m

HR2631F
179,90 €

AVT
ANTI VIBRATION TECHNOLOGY

AVT
ANTI VIBRATION TECHNOLOGY

AVT
ANTI VIBRATION TECHNOLOGY

Kombinované kladivo

HR2630T 26 mm, SDS-PLUS

325 



Rýchlosklučovadlo



Prikon	800W
Sila príklepu	EPTA-Procedure 05/2009: 2,4 J
Max. výkon	Betón: 26 mm
	Vŕtacia korunka: 68 mm
	Diamantová vŕtacia korunka: 80 mm
	Železo: 13 mm
	Drevo: 32 mm
Počet úderov / min ⁻¹	0 – 4.600
Voľnobežné otáčky	0 – 1.200
Úroveň akustického tlaku	90 dB(A)
Úroveň akustického výkonu	101 dB(A)
Vibrácie	Vŕtanie s príklepom: 15,0 m/s ²
Rozmery	385×77×209 mm
Hmotnosť	3,0 – 3,5 kg
Dĺžka privodného kábla	2,5 m

HR2630T
219,90 €

Kombinované kladivo

HR2630 26 mm, SDS-PLUS

325 



Prikon	800W
Sila príklepu	EPTA-Procedure 05/2009: 2,4 J
Max. výkon	Betón: 26 mm
	Vŕtacia korunka: 68 mm
	Diamantová vŕtacia korunka: 80 mm
	Železo: 13 mm
	Drevo: 32 mm
Počet úderov / min ⁻¹	0 – 4.600
Voľnobežné otáčky	0 – 1.200
Úroveň akustického tlaku	90 dB(A)
Úroveň akustického výkonu	101 dB(A)
Vibrácie	Vŕtanie s príklepom: 15,0 m/s ²
Rozmery	385×77×209 mm
Hmotnosť	2,8 – 3,3 kg
Dĺžka privodného kábla	2,5 m

HR2630
169,90 €

HR2630X7
184,90 €

X7 – sklúčovadlo

Vŕtacie kladivo

HR2600 28 mm, SDS-PLUS

325 



Prikon	800W
Sila príklepu	EPTA-Procedure 05/2009: 2,4 J
Max. vŕtací výkon	Betón: 26 mm
	Železo: 13 mm
	Drevo: 32 mm
Počet úderov / min ⁻¹	0 – 4.600
Voľnobežné otáčky	0 – 1.200
Úroveň akustického tlaku	91 dB(A)
Úroveň akustického výkonu	102 dB(A)
Vibrácie	Vŕtanie s príklepom do betónu: 15,5 m/s ²
	Vŕtanie do železa: 2,5 m/s ²
Rozmery	361×77×209 mm
Hmotnosť	3,0 – 3,4 kg
Dĺžka privodného kábla	2,5 m

HR2600
149,90 €

Kombinované kladivo

HR2811FT 28 mm, SDS-PLUS

325 



Rýchlosklučovadlo



Prikon	800W
Sila príklepu	EPTA-Procedure 05/2009: 2,9 J
Max. vŕtací výkon	Betón: 28 mm
	Železo: 13 mm
	Drevo: 32 mm
Počet úderov / min ⁻¹	0 – 4.500
Voľnobežné otáčky	0 – 1.100
Úroveň akustického tlaku	90 dB(A)
Úroveň akustického výkonu	101 dB(A)
Vibrácie	Vŕtanie s príklepom do betónu: 15,0 m/s ²
	Vŕtanie do železa: 2,5 m/s ²
Rozmery	345×89×225 mm
Hmotnosť	3,6 – 3,9 kg
Dĺžka privodného kábla	2,5 m

HR2811FT
369,90 €

Kombinované kladivo

HR2810T 28 mm, SDS-PLUS

325 



Rýchlosklučovadlo

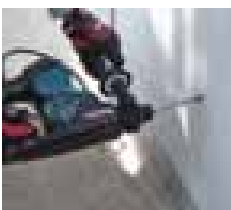

Prikon	800W
Sila príklepu	EPTA-Procedure 05/2009: 2,9 J
Max. vŕtací výkon	Betón: 28 mm
	Železo: 13 mm
	Drevo: 32 mm
Počet úderov / min ⁻¹	0 – 4.500
Voľnobežné otáčky	0 – 1.100
Úroveň akustického tlaku	89 dB(A)
Úroveň akustického výkonu	100 dB(A)
Vibrácie	Vŕtanie s príklepom do betónu: 20 m/s ²
	Vŕtanie do železa: 2,5 m/s ²
Rozmery	339×89×225 mm
Hmotnosť	3,5 – 3,8 kg
Dĺžka privodného kábla	2,5 m

HR2810T
349,90 €

Kombinované kladivo

HR2810 28 mm, SDS-PLUS

325 

Príkon	800W
Síla príklepu	EPTA-Procedure 05/2009: 2,8 J
Max. vŕtací výkon	Betón: 28 mm
	Železo: 13 mm
	Drevo: 32 mm
Počet úderov / min ⁻¹	0 – 4.500
Vofnobežné otáčky	0 – 1.100
Úroveň akustického tlaku	89 dB(A)
Úroveň akustického výkonu	100 dB(A)
Vibrácie	Vŕtanie s príklepom do betónu: 20 m/s ²
	Vŕtanie do železa: 2,5 m/s ²
Rozmery	314×89×225 mm
Hmotnosť	3,4 – 3,8 kg
Dĺžka privodného kábla	2,5 m

HR2810
299,90 €

Vŕtacie kladivo

HR2800 28 mm, SDS-PLUS

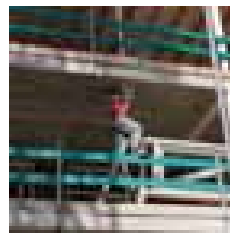
325 

Príkon	800W
Síla príklepu	EPTA-Procedure 05/2009: 2,8 J
Max. vŕtací výkon	Betón: 28 mm
	Železo: 13 mm
	Drevo: 32 mm
Počet úderov / min ⁻¹	0 – 4.500
Vofnobežné otáčky	0 – 1.100
Úroveň akustického tlaku	89 dB(A)
Úroveň akustického výkonu	100 dB(A)
Vibrácie	Vŕtanie s príklepom do betónu: 20 m/s ²
	Vŕtanie do železa: 2,5 m/s ²
Rozmery	314×89×225 mm
Hmotnosť	3,4 – 3,8 kg
Dĺžka privodného kábla	2,5 m

HR2800
279,90 €

Kombinované kladivo

HR3210FCT 32 mm, SDS-PLUS

350 

Rýchlosľučovadlo

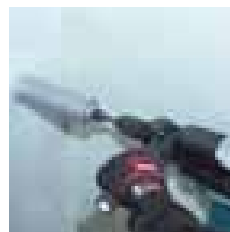

Príkon	850W
Síla príklepu	EPTA-Procedure 05/2009: 4,9 J
Max. vŕtací výkon	Betón: 32 mm
	Železo: 13 mm
	Drevo: 32 mm
	Vŕtanie s korunkou: 90 mm
Počet úderov / min ⁻¹	1.650 – 3.300
Vofnobežné otáčky	315 – 630
Úroveň akustického tlaku	88 dB(A)
Úroveň akustického výkonu	99 dB(A)
Vibrácie	Vŕtanie s príklepom do betónu: 10,0 m/s ²
	Vŕtanie do železa: 2,5 m/s ²
Rozmery	424×114×239 mm
Hmotnosť	5,4 – 5,6 kg
Dĺžka privodného kábla	5,0 m

HR3210FCT
769,90 €

Kombinované kladivo

HR3210C 32 mm, SDS-PLUS

350 

Príkon	850W
Síla príklepu	EPTA-Procedure 05/2009: 5 J
Max. vŕtací výkon	Betón: 32 mm
	Železo: 13 mm
	Drevo: 32 mm
	Vŕtanie s korunkou: 90 mm
Počet úderov / min ⁻¹	1.650 – 3.300
Vofnobežné otáčky	315 – 630
Úroveň akustického tlaku	89 dB(A)
Úroveň akustického výkonu	100 dB(A)
Vibrácie	Vŕtanie s príklepom do betónu: 10,0 m/s ²
	Vŕtanie do železa: 2,5 m/s ²
Rozmery	398×114×239 mm
Hmotnosť	5,2 – 5,6 kg
Dĺžka privodného kábla	5,0 m

HR3210C
599,90 €

Kombinované kladivo

HR3200C 32 mm, SDS-PLUS

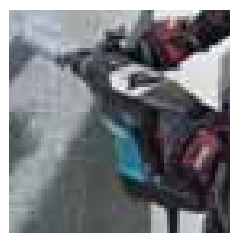
350 

Príkon	850W
Síla príklepu	EPTA-Procedure 05/2009: 5,1 J
Max. vŕtací výkon	Betón: 32 mm
	Železo: 13 mm
	Drevo: 32 mm
	Vŕtanie s korunkou: 90 mm
Počet úderov / min ⁻¹	1.650 – 3.300
Vofnobežné otáčky	315 – 630
Úroveň akustického tlaku	89 dB(A)
Úroveň akustického výkonu	100 dB(A)
Vibrácie	Vŕtanie s príklepom do betónu: 18,0 m/s ²
	Vŕtanie do železa: 2,5 m/s ²
Rozmery	398×108×239 mm
Hmotnosť	4,8 – 5,2 kg
Dĺžka privodného kábla	5,0 m

HR3200C
569,90 €
AVT
 ANTI VIBRATION TECHNOLOGY

AVT
 ANTI VIBRATION TECHNOLOGY

Kombinované kladivo
HR3540C 35 mm, SDS-MAX

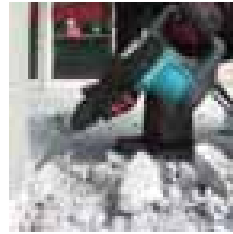
 350 

Prikon	850W
Sila príklepu	EPTA-Procedure 05/2009: 5,6 J
Max. vŕtací výkon	Betón: 35 mm Železo: 13 mm Drevo: 32 mm
Počet úderov / min ⁻¹	1.650 – 3.300
Voľnobežné otáčky	315 – 630
Úroveň akustického tlaku	93 dB(A)
Úroveň akustického výkonu	104 dB(A)
Vibrácie	Vŕtanie s príklepom do betónu: 18,0 m/s ² Vŕtanie do železa: 2,5 m/s ²
Rozmery	439×108×239 mm
Hmotnosť	5,2 – 5,3 kg
Dĺžka privodného kábla	5,0 m

HR3540C
599,90 €
Kombinované kladivo
HR4013C 40 mm, SDS-MAX

 350 

Prikon	1.100W
Sila príklepu	EPTA-Procedure 05/2009: 8 J
Max. vŕtací výkon	Betón s vŕtákom: 40 mm Betón s vŕtacom korunkou: 105 mm
Počet úderov / min ⁻¹	1.450 – 2.900
Voľnobežné otáčky	250 – 500
Úroveň akustického tlaku	92 dB(A)
Úroveň akustického výkonu	103 dB(A)
Vibrácie	Sekanie s bočnou rukoväťou: 4,5 m/s ² Vŕtanie s príklepom do betónu: 5,0 m/s ²
Rozmery	479×112×263 mm
Hmotnosť	6,8 – 6,9 kg
Dĺžka privodného kábla	5,0 m

HR4013C
699,90 €
Kombinované kladivo
HR4003C 40 mm, SDS-MAX

 350 



Prikon	1.100W
Sila príklepu	EPTA-Procedure 05/2009: 8,3 J
Max. vŕtací výkon	Betón s vŕtákom: 40 mm Betón s vŕtacom korunkou: 105 mm
Počet úderov / min ⁻¹	1.450 – 2.900
Voľnobežné otáčky	250 – 500
Úroveň akustického tlaku	92 dB(A)
Úroveň akustického výkonu	103 dB(A)
Vibrácie	Sekanie s bočnou rukoväťou: 9,0 m/s ² Vŕtanie s príklepom do betónu: 10,0 m/s ²
Rozmery	479×106×263 mm
Hmotnosť	6,2 – 6,4 kg
Dĺžka privodného kábla	5,0 m

HR4003C
659,90 €
Kombinované kladivo
HR4002 40 mm, SDS-MAX

 350 

Prikon	1.050W
Sila príklepu	EPTA-Procedure 05/2009: 6,1 J
Max. vŕtací výkon	Betón s vŕtákom: 40 mm Betón s vŕtacom korunkou: 105 mm
Počet úderov / min ⁻¹	2.500
Voľnobežné otáčky	680
Úroveň akustického tlaku	92 dB(A)
Úroveň akustického výkonu	103 dB(A)
Vibrácie	Vŕtanie s príklepom do betónu: 17,5 m/s ²
Rozmery	458×114×256 mm
Hmotnosť	6,6 – 6,8 kg
Dĺžka privodného kábla	5,0 m

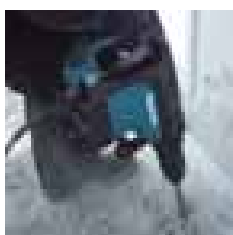
HR4002
499,90 €
Kombinované kladivo
HR4511C 45 mm, SDS-MAX

 175 

Prikon	1.350W
Sila príklepu	EPTA-Procedure 05/2009: 9,4 J
Max. vŕtací výkon	Betón s vŕtákom: 45 mm Betón s vŕtacom korunkou: 125 mm
Počet úderov / min ⁻¹	1.250 – 2.750
Voľnobežné otáčky	130 – 280
Úroveň akustického tlaku	94 dB(A)
Úroveň akustického výkonu	105 dB(A)
Vibrácie	Vŕtanie s príklepom do betónu: 7,5 m/s ² Sekanie s bočnou rukoväťou: 7,5 m/s ²
Rozmery	458×136×288 mm
Hmotnosť	9,0 – 9,1 kg
Dĺžka privodného kábla	5,0 m

HR4511C
889,90 €

Kombinované kladivo

HR4501C 45 mm, SDS-MAX

175 

Príkon	1.350W
Síla príklepu	EPTA-Procedure 05/2009: 10,1 J
Max. vŕtací výkon	Betón s vŕtákom: 45 mm Betón s vŕtacom korunkou: 125 mm
Počet úderov / min ⁻¹	1.250 – 2.750
Voľnobežné otáčky	130 – 280
Úroveň akustického tlaku	94 dB(A)
Úroveň akustického výkonu	105 dB(A)
Vibrácie	Vŕtanie s príklepom do betónu: 16,0 m/s ² Sekanie s bočnou rukoväťou: 12,5 m/s ²
Rozmery	458×121×288 mm
Hmotnosť	8,2 – 8,4 kg
Dĺžka privodného kábla	5,0 m

HR4501C
799,90 €

Kombinované kladivo

HR5212C 52 mm, SDS-MAX

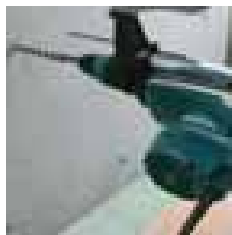
175 

Príkon	1.510W
Síla príklepu	EPTA-Procedure 05/2009: 20 J
Max. vŕtací výkon	Betón s vŕtákom: 52 mm Betón s vŕtacom korunkou: 160 mm
Počet úderov / min ⁻¹	1.100 – 2.250
Voľnobežné otáčky	150 – 310
Úroveň akustického tlaku	98 dB(A)
Úroveň akustického výkonu	109 dB(A)
Vibrácie	Sekanie s bočnou rukoväťou: 7,0 m/s ² Vŕtanie s príklepom do betónu: 9,0 m/s ²
Rozmery	599×140×287 mm
Hmotnosť	11,9 – 12,0 kg
Dĺžka privodného kábla	5,0 m

HR5212C
999,90 €

Kombinované kladivo

HR5202C 52 mm, SDS-MAX

175 

Príkon	1.510W
Síla príklepu	EPTA-Procedure 05/2009: 19,1 J
Max. vŕtací výkon	Betón s vŕtákom: 52 mm Betón s vŕtacom korunkou: 160 mm
Počet úderov / min ⁻¹	1.100 – 2.250
Voľnobežné otáčky	150 – 310
Úroveň akustického tlaku	99 dB(A)
Úroveň akustického výkonu	110 dB(A)
Vibrácie	Sekanie s bočnou rukoväťou: 10,5 m/s ² Vŕtanie s príklepom do betónu: 17,0 m/s ²
Rozmery	599×134×287 mm
Hmotnosť	10,9 – 11,1 kg
Dĺžka privodného kábla	5,0 m

HR5202C
899,90 €

Sekacie kladivo

HM0871C SDS-MAX

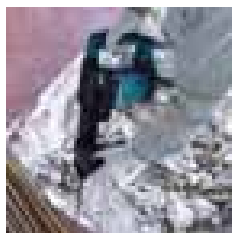
350 

Príkon	1.100W
Síla príklepu	EPTA-Procedure 05/2009: 8,1 J
Počet úderov / min ⁻¹	1.100 – 2.650
Úroveň akustického tlaku	86 dB(A)
Úroveň akustického výkonu	97 dB(A)
Vibrácie	Sekanie s bočnou rukoväťou: 8,0 m/s ²
Rozmery	466×116×230 mm
Hmotnosť	5,6 – 5,8 kg
Dĺžka privodného kábla	5,0 m

HM0871C
499,90 €

Sekacie kladivo

HM0870C SDS-MAX

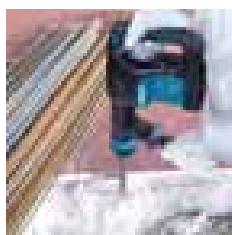
350 

Príkon	1.100W
Síla príklepu	EPTA-Procedure 05/2009: 7,6 J
Počet úderov / min ⁻¹	1.100 – 2.650
Úroveň akustického tlaku	87 dB(A)
Úroveň akustického výkonu	98 dB(A)
Vibrácie	Sekanie s bočnou rukoväťou: 11,0 m/s ²
Rozmery	449×109×230 mm
Hmotnosť	5,1 – 5,3 kg
Dĺžka privodného kábla	5,0 m

HM0870C
449,90 €
AVT **SOFT**
ANTI VIBRATION TECHNOLOGY **NO LOAD**

Búracie kladivo

HM1111C SDS-MAX

175 



Stroj je dodávaný bez zobrazeného sekáča



Prikon	1.300W
Sila príklepu	EPTA-Procedure 05/2009: 11,2 J
Počet úderov / min ⁻¹	1.100 – 2.650
Vibrácie	Sekanie s bočnou rukoväťou: 7,5 m/s ²

Úroveň akustického tlaku	88 dB(A)
Úroveň akustického výkonu	99 dB(A)
Rozmery	528×126×247 mm
Hmotnosť	7,8 – 8,0 kg
Dĺžka privodného kábla	4,0 m

HM1111C
749,90 €

Búracie kladivo

HM1101C SDS-MAX

175 



Stroj je dodávaný bez zobrazeného sekáča



Prikon	1.300W
Sila príklepu	EPTA-Procedure 05/2009: 11,5 J
Počet úderov / min ⁻¹	1.100 – 2.650
Vibrácie	Sekanie s bočnou rukoväťou: 13,5 m/s ²
Úroveň akustického tlaku	90 dB(A)
Úroveň akustického výkonu	101 dB(A)
Rozmery	528×115×247 mm
Hmotnosť	7,2 – 7,3 kg
Dĺžka privodného kábla	4,0 m

HM1101C
699,90 €

Búracie kladivo

HM1213C SDS-MAX

175 



Stroj je dodávaný bez zobrazeného sekáča



Prikon	1.510W
Sila príklepu	EPTA-Procedure 05/2009: 18,6 J
Počet úderov / min ⁻¹	950 – 1.900
Úroveň akustického tlaku	75 dB(A)
Úroveň akustického výkonu	95 dB(A)
Vibrácie	Sekanie s bočnou rukoväťou: 8,0 m/s ²
Rozmery	576×149×265 mm
Hmotnosť	10,8 kg
Dĺžka privodného kábla	5,0 m

HM1213C
699,90 €

AVT **SOFT**
ANTI-VIBRATION TECHNOLOGY **NO LOAD**

Búracie kladivo

HM1205C SDS-MAX

175 



Stroj je dodávaný bez zobrazeného sekáča

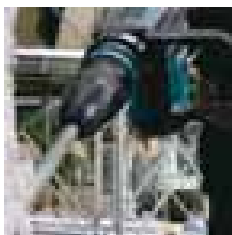

Prikon	1.510W
Sila príklepu	EPTA-Procedure 05/2009: 19,1 J
Počet úderov / min ⁻¹	950 – 1.900
Úroveň akustického tlaku	79 dB(A)
Úroveň akustického výkonu	93 dB(A)
Vibrácie	Sekanie s bočnou rukoväťou: 18,5 m/s ²
Rozmery	576×128×265 mm
Hmotnosť	9,7 kg
Dĺžka privodného kábla	5,0 m

HM1205C
599,90 €

Búracie kladivo

HM1203C SDS-MAX

175 



Stroj je dodávaný bez zobrazeného sekáča



Prikon	1.510W
Sila príklepu	EPTA-Procedure 05/2009: 19,1 J
Počet úderov / min ⁻¹	950 – 1.900
Úroveň akustického tlaku	81 dB(A)
Úroveň akustického výkonu	95 dB(A)
Vibrácie	Sekanie s bočnou rukoväťou: 16,5 m/s ²
Rozmery	576×128×265 mm
Hmotnosť	9,7 kg
Dĺžka privodného kábla	5,0 m

HM1203C
599,90 €

Búracie kladivo

HM1214C SDS-MAX

175 

Stroj je dodávaný bez zobrazeného sekáča



Príkon	1.510W
Síla príklepu	EPTA-Procedure 05/2009: 19,9 J
Počet úderov / min ⁻¹	950 – 1.900
Úroveň akustického tlaku	78 dB(A)
Úroveň akustického výkonu	98 dB(A)
Rozmery	700×129×265 mm
Hmotnosť	12,3 kg
Dĺžka privodného kábla	5,0 m

HM1214C
899,90 €

AVT **SOFT**
ANTI VIBRATION TECHNOLOGY **NO LOAD**



Búracie kladivo

HM1317C 30 mm Hex

175 

Stroj je dodávaný bez zobrazeného sekáča

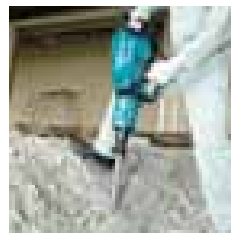

Príkon	1.510W
Síla príklepu	EPTA-Procedure 05/2009: 25 (100 – 127 V: 21) J
Počet úderov / min ⁻¹	730 – 1.450
Úroveň akustického tlaku	81 dB(A)
Úroveň akustického výkonu	101 dB(A)
Vibrácie	Sekanie s bočnou rukoväťou: 8,5 m/s ²
Rozmery	715×129×266 mm
Hmotnosť	17 kg
Dĺžka privodného kábla	5,0 m

HM1317C
999,00 €

AVT **SOFT**
ANTI VIBRATION TECHNOLOGY **NO LOAD**



Búracie kladivo

HM1307C 30 mm Hex

175 

Stroj je dodávaný bez zobrazeného sekáča

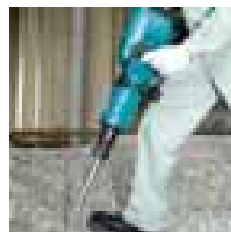

Príkon	1.510W
Síla príklepu	EPTA-Procedure 05/2009: 25,5 J
Počet úderov / min ⁻¹	730 – 1.450
Úroveň akustického tlaku	81 dB(A)
Úroveň akustického výkonu	101 dB(A)
Vibrácie	Sekanie s bočnou rukoväťou: 12,5 m/s ²
Rozmery	715×129×266 mm
Hmotnosť	15,3 kg
Dĺžka privodného kábla	5,0 m

HM1307C
929,90 €

AVT **SOFT**
ANTI VIBRATION TECHNOLOGY **NO LOAD**



Búracie kladivo

HM1317CB 28,6 mm Hex

175 

Stroj je dodávaný bez zobrazeného sekáča



Príkon	1.510W
Síla príklepu	EPTA-Procedure 05/2009: 26,5 (100 – 127 V: 24) J
Počet úderov / min ⁻¹	730 – 1.450
Úroveň akustického tlaku	81 dB(A)
Úroveň akustického výkonu	101 dB(A)
Vibrácie	Sekanie s bočnou rukoväťou: 7,0 m/s ²
Rozmery	824×129×266 mm
Hmotnosť	19 kg
Dĺžka privodného kábla	5,0 m

HM1317CB
1 149,00 €

AVT **SOFT**
ANTI VIBRATION TECHNOLOGY **NO LOAD**



Búracie kladivo

HM1307CB 28,6 mm Hex

175 

Stroj je dodávaný bez zobrazeného sekáča



Príkon	1.510W
Síla príklepu	EPTA-Procedure 05/2009: 23,6 J
Počet úderov / min ⁻¹	730 – 1.450
Úroveň akustického tlaku	81 dB(A)
Úroveň akustického výkonu	101 dB(A)
Vibrácie	Sekanie s bočnou rukoväťou: 12,0 m/s ²
Rozmery	824×129×266 mm
Hmotnosť	17,3 kg
Dĺžka privodného kábla	5,0 m

HM1307CB
1 099,00 €

AVT **SOFT**
ANTI VIBRATION TECHNOLOGY **NO LOAD**



Búracie kladivo

HM1802 28,6 mm Hex

218 

Stroj je dodávaný bez zobrazeného sekáča

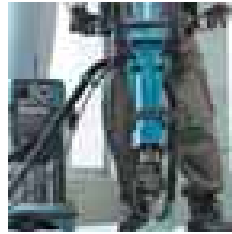

Prikon	2.000W
Sila príklepu	EPTA-Procedure 05/2009: 71,4 J
Počet úderov / min ⁻¹	870
Úroveň akustického tlaku	95 dB(A)
Úroveň akustického výkonu	106 dB(A)
Rozmery	843×210×608 mm
Hmotnosť	29,4 kg
Dĺžka privodného kábla	5,0 m

HM1802
1 499,00 €**Búracie kladivo**

HM1812 28,6 mm Hex

218 

Stroj je dodávaný bez zobrazeného sekáča

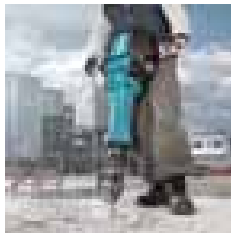
AVT **SOFT**
ANTI VIBRATION TECHNOLOGY **NOLOAD**

Prikon	2.000W
Sila príklepu	EPTA-Procedure 05/2009: 72,8 J
Počet úderov / min ⁻¹	870
Úroveň akustického tlaku	96 dB(A)
Úroveň akustického výkonu	107 dB(A)
Rozmery	843×210×608 mm
Hmotnosť	31,3 kg
Dĺžka privodného kábla	5,0 m

HM1812
1 699,00 €**Sekacie kladivo**

HK1820 SDS-PLUS

350 

Stroj je dodávaný bez zobrazeného sekáča



Prikon	550W
Sila príklepu	EPTA-Procedure 05/2009: 3,1 J
Počet úderov / min ⁻¹	0 – 3.200
Rozmery	351×102×203 mm
Hmotnosť	3,4 kg
Dĺžka privodného kábla	5,0 m

HK1820
479,90 €

AVT & SOFT NO LOAD

ANTI VIBRATION TECHNOLOGY



Extrémne nízke vibrácie

AVT
ANTI VIBRATION TECHNOLOGY
&
**SOFT
NO LOAD**

50mm
Vŕtacie kladivo
HR5212C



40mm
Vŕtacie kladivo
HR4013C



Búracie kladivo
HM0871C



Búracie kladivo
HM1111C
HM1213C



Búracie kladivo
HM1214C



Búracie kladivo
HM1317C
HM1317CB
HM1812



26mm
Kombinované kladivo
s odsávaním
HR2651



26mm
Kombinované kladivo
s odsávaním
HR2661



26mm
Kombinované kladivo
s odsávaním
HR2651T



18mm
Vŕtacie kladivo
HR1841F



26mm
Kombinované kladivo
HR2641



26mm
Kombinované kladivo
HR2631FT / HR2631F



Vŕtacie kladivo
HR2601



32mm
Kombinované kladivo
HR3210FCT / HR3210C



35mm
Kombinované kladivo
HR3541FC



40mm
Vŕtacie kladivo
HR4013C



45mm
Vŕtacie kladivo
HR4511C / HR4510C



52mm
Vŕtacie kladivo
HR5212C



AVT
ANTI VIBRATION TECHNOLOGY

Vrtanie / vrtanie s príklepom

*s odsávaním

Model	Typ	Max. vŕtací výkon	Príkon (W)	Impact energy (J)		Hmotnosť (kg)	AVT	Kontrola otáčok	Svetlo	Rýchlosťklúčovadlo
				EPTA-Procedure 05/2009	Makita					

SDS Plus

HR1841F/HR1840	Vŕtacie	18	470	1,4	1,4	2,0 - 2,5 kg (4,5 - 5,4 lbs)	•/-		•/-	
HR2230	Vŕtacie	22	710	2,2	2,3	2,6 - 3,1 kg (5,8 - 6,8 lbs)				
HR2320T	Kombinované	23	720	2,3	2,3	2,9 - 3,2 kg (6,4 - 7,0 lbs)				•
HR2300	Vŕtacie	23	720	2,3	2,3	2,7 - 3,1 kg (5,9 - 6,9 lbs)				
HR2470FT	Kombinované	24	780	2,4	2,7	3,0 - 3,3 kg (6,7 - 7,3 lbs)			•	•
HR2470T	Kombinované	24	780	2,4	2,7	3,0 - 3,3 kg (6,7 - 7,3 lbs)				•
HR2470/F	Kombinované	24	780	2,4	2,7	2,9 - 3,3 kg (6,4 - 7,3 lbs)			-/•	
HR2460/F	Vŕtacie	24	780	2,4	2,7	2,8 - 3,2 kg (6,1 - 7,0 lbs)			-/•	
HR2475(D handle)	Kombinované	24	780	2,3	2,7	3,0 - 3,4 kg (6,6 - 7,6 lbs)				
*HR2653T	Kombinované	26	800	2,2	2,9	3,2 - 4,5 kg (7,2 - 9,9 lbs,)	•			•
*HR2653	Kombinované	26	800	2,2	2,9	3,1 - 4,3 kg (6,9 - 9,6 lbs,)	•			
*HR2652	Kombinované	26	800	2,2	2,9	3,0 - 4,3 kg (6,7 - 9,4 lbs,)				
*HR2663(D handle)	Kombinované	26	800	2,2	2,9	3,3 - 4,6 kg (7,3 - 10,0 lbs,)	•			
HR2641(D handle)	Kombinované	26	800	2,4	2,9	3,1 - 3,5 kg (6,8 - 7,8 lbs)	•			
HR2631FT	Kombinované	26	800	2,4	2,9	3,1 - 3,6 kg (6,8 - 7,9 lbs)	•		•	•
HR2631F	Kombinované	26	800	2,4	2,9	2,9 - 3,4 kg (6,4 - 7,4 lbs)	•		•	
HR2630T	Kombinované	26	800	2,4	2,9	3,0 - 3,5 kg (6,6 - 7,7 lbs)				•
HR2630	Kombinované	26	800	2,4	2,9	2,8 - 3,3 kg (6,3 - 7,2 lbs)				
HR2601	Vŕtacie	26	800	2,4	2,9	3,1 - 3,6 kg (6,9 - 7,8 lbs)	•			
HR2600	Vŕtacie	26	800	2,4	2,9	3,0 - 3,4 kg (6,5 - 7,5 lbs)				
HR2811FT	Kombinované	28	800	2,9	2,9	3,6 - 3,9 kg (8,0 - 8,6 lbs)			•	•
HR2811F	Kombinované	28	800	2,8	2,9	3,5 - 3,9 kg (7,7 - 8,7 lbs)			•	
HR2810T	Kombinované	28	800	2,9	2,9	3,5 - 3,8 kg (7,8 - 8,4 lbs)				•
HR2810	Kombinované	28	800	2,8	2,9	3,4 - 3,8 kg (7,5 - 8,5 lbs)				
HR2800	Vŕtacie	28	800	2,8	2,9	3,4 - 3,8 kg (7,4 - 8,4 lbs)				
HR3210FCT	Kombinované	32	850	4,9	5,5	5,4 - 5,6 kg (11,9 - 12,3 lbs)	•		•	•
HR3210C	Vŕtacie	32	850	5	5,5	5,2 - 5,6 kg (11,4 - 12,4 lbs)	•			
HR3200C	Kombinované	32	850	5,1	5,5	4,8 - 5,2 kg (10,5 - 11,5 lbs)				

17 mm HEX

HR3530	Vŕtacie	35	1 010	-	6,2	5,8 kg (12,8 lbs)				
HR4030C	Vŕtacie	40	1 100	-	9,2	6,9 kg (15,2 lbs)				

19 mm HEX

Drážková hriadel'







HR4041C	Vŕtacie	40	1 100		9,2	6,7 kg (14,8 lbs)				
HR5000	Vŕtacie	50	1 200	11,3	11,8	9,9 kg (21,8 lbs)				

SDS Max

HR3541FC	Kombinované	35	850	5,7	6,3	5,6 - 5,7 kg (12,3 - 12,6 lbs)	•		•	
HR3540C	Kombinované	35	850	5,6	6,3	5,2 - 5,3 kg (11,4 - 11,6 lbs)				
HR4013C	Vŕtacie	40	1 100	8	11,4	6,8 - 6,9 kg (14,9 - 15,3 lbs)	•	•		
HR4003C	Vŕtacie	40	1 100	8,3	11,4	6,2 - 6,4 kg (13,7 - 14,1 lbs)				
HR4002	Vŕtacie	40	1 050	6,1	6,2	6,6 - 6,8 kg (14,6 - 15,0 lbs)				
HR4511C	Vŕtacie	45	1 350	9,4	12,5	9,0 - 9,1 kg (19,8 - 20,1 lbs)	•			
HR4510C	Vŕtacie	45	1 350	9,4	12,5	8,9 - 9,0 kg (19,5 - 19,9 lbs)	•			
HR4501C	Vŕtacie	45	1 350	10,1	12,5	8,2 - 8,4 kg (18,1 - 18,5 lbs)				
HR5212C	Vŕtacie	52	1 510	20	21	11,9 - 12,0 kg (26,2 - 26,5 lbs)	•	•		
HR5202C	Vŕtacie	52	1 510	19,1	21	10,9 - 11,1 kg (24,1 - 24,4 lbs)				

REZANIE



-  Dvojitá izolácia
-  Nastavenie otáčok
-  Brzda
-  Obmedzovač momentu
-  Konštantné otáčky
-  Obmedzovač rozbehového prúdu
-  Rez v oblúku
-  Bajonetové upínanie
-  Zabudované osvetlenie
-  Rez pod uhlom
-  Odsávanie prachu
-  Prepravný kufor

Diamantová rezačka

4100KB 125 mm

303 



Prikon	1.400W
Priemer kotúča	125 mm
Max. rezný výkon	40,0 mm
Voľnobežné otáčky	12.200
Vibrácie	Rezanie betónu: 6,0 m/s²
Úroveň akustického tlaku	96 dB(A)
Úroveň akustického výkonu	107 dB(A)
Rozmery	231×220×179 mm
Hmotnosť	3,0 kg
Dĺžka privodného kábla	2,5 m



4100KB
99,90 €

Rezačka

4112HS 305 mm

204 



Prikon	2.400W
Max. rezný výkon	100 mm
Priemer kotúča	305 mm
Voľnobežné otáčky	5.000
Celková dĺžka	648 mm
Hmotnosť	10,4 kg
Dĺžka privodného kábla	2,5 m



4112HS
619,90 €

Drážkovacia fréza

SG1251 125 mm

318 



Prikon	1.400W
Max. rezný výkon	Hĺbka: 0 – 30 mm Šírka: 6 – 30 mm
Priemer kotúča	125 mm
Voľnobežné otáčky	10.000
Rozmery	350×151×178 mm
Hmotnosť	4,3 kg
Dĺžka privodného kábla	5,0 m



SG1251J
579,90 €

Drážkovacia fréza

SG181 180 mm

318 



Prikon	2.150 W
Max. rezný výkon	Hĺbka: 15 – 60 mm Šírka: 9 – 43 mm
Priemer kotúča	180 mm
Voľnobežné otáčky	7 200
Hmotnosť	5,6 kg



SG181
1 299,00 €



Drážkovacia fréza

SG150 150 mm



Príkon	1.800W
Priemer kotúča	150 mm
Max. rezný výkon	Hĺbka: 7 – 45 mm Šírka: 7 – 35 mm
Voľnobežné otáčky	7.800
Celková dĺžka	410 mm
Hmotnosť	5,6 kg

SG150
929,90 €

Rezač na železo

4131 185 mm

303



Príkon	1.100W
Priemer kotúča	185 mm
Max. rezný výkon	63 mm
Voľnobežné otáčky	3.500
Celková dĺžka	358 mm
Hmotnosť	4,8 kg
Dĺžka privodného kábla	2,5 m

4131
399,90 €

Rezač na železo

LC1230 305 mm

203



Príkon	1.750W
Priemer kotúča	305 mm
Max. rezný výkon	90°: 115 mm 90°: 75×150 mm 45°: 90 mm 45°: 85×85 mm
Voľnobežné otáčky	1.300
Rozmery	516×306×603 mm
Hmotnosť	19,3 kg
Dĺžka privodného kábla	2,5 m

LC1230N
499,90 €

Rezač na železo

LW1400 355 mm

203



Príkon	2.200W
Priemer kotúča	355 mm
Voľnobežné otáčky	3.800
Max. rezný výkon 90°	Gulatina: 127 mm Profil – obdĺžnik: 115×130 mm Profil – obdĺžnik: 102×194 mm Profil – obdĺžnik: 70×233 mm
Max. rezný výkon 45°	Gulatina: 127 mm Profil – obdĺžnik: 115×103 mm
Vibrácie	2,5 m/s ²
Úroveň akustického tlaku	102 dB(A)
Úroveň akustického výkonu	110 dB(A)
Rozmery	530×295×640 mm
Hmotnosť	18,7 kg
Dĺžka privodného kábla	2,5 m

LW1400
269,90 €

Rezač na železo

LW1401 355 mm

203

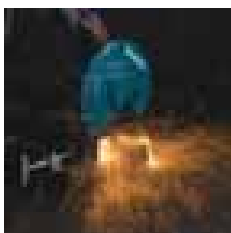

Príkon	2.200W
Priemer kotúča	355 mm
Voľnobežné otáčky	3.800
Max. rezný výkon 90°	Gulatina: 127 mm Profil – obdĺžnik: 115×130 mm Profil – obdĺžnik: 102×194 mm Profil – obdĺžnik: 70×233 mm
Max. rezný výkon 45°	Gulatina: 127 mm Profil – obdĺžnik: 115×103 mm
Vibrácie	2,5 m/s ²
Úroveň akustického tlaku	102 dB(A)
Úroveň akustického výkonu	110 dB(A)
Rozmery	500×295×640 mm
Hmotnosť	18,3 kg
Dĺžka privodného kábla	2,5 m

LW1401
249,90 €

Pásová píla

2107F

303 



Prikon	710W
Max. rezný výkon	Gulatina: 120 mm
Rychlosť rezného pásu	60 m / min
Rozmery	508×188×256 mm
Hmotnosť	6,3 kg
Dĺžka privodného kábla	2,5 m

2107FK
459,90 €

Nožnice

JS1601 1,6 mm

459 



Prikon	380W
Max. rezný výkon	Oceľ do 400 N/mm ² : 1,6 mm Oceľ do 600 N/mm ² : 1,2 mm Oceľ do 800 N/mm ² : 0,8 mm Hliník do 200 N/mm ² : 2,5 mm
Min. rádius	250 mm
Počet strihov za minútu	4,500
Rozmery	320×70×78 mm
Hmotnosť	1,4 kg
Dĺžka privodného kábla	2,5 m

JS1601
339,90 €

Nožnice

JS1000 1,6 mm

459 



Prikon	380W
Max. rezný výkon	Oceľ do 400 N/mm ² : 1,0 mm Oceľ do 600 N/mm ² : 0,7 mm Oceľ do 800 N/mm ² : 0,5 mm Hliník do 200 N/mm ² : 2,5 mm
Min. rádius	30 mm
Počet strihov za minútu	4,500
Rozmery	322×70×78 mm
Hmotnosť	1,4 kg
Dĺžka privodného kábla	2,5 m

JS1000
359,90 €

Nožnice

JS1602 1,6 mm

325 



Prikon	380W
Max. rezný výkon	Oceľ do 400 N/mm ² : 1,6 mm Oceľ do 600 N/mm ² : 1,2 mm Oceľ do 800 N/mm ² : 0,8 mm Hliník do 200 N/mm ² : 2,5 mm
Min. rádius	30 mm
Počet strihov za minútu	4,000
Rozmery	255×74×146 mm
Hmotnosť	1,6 kg
Dĺžka privodného kábla	2,5 m

JS1602
299,90 €

Nožnice

JS3201 3,2 mm

303 



Prikon	710W
Max. rezný výkon	Oceľ do 400 N/mm ² : 3,2 mm Oceľ do 600 N/mm ² : 2,5 mm Oceľ do 800 N/mm ² : 1,5 mm Hliník do 200 N/mm ² : 4,0 mm
Min. rádius	50 mm
Počet strihov za minútu	1,600
Rozmery	213×90×239 mm
Hmotnosť	3,4 kg
Dĺžka privodného kábla	2,5 m

JS3201J
399,90 €

Prestrihovač

JN1601 1,6 mm

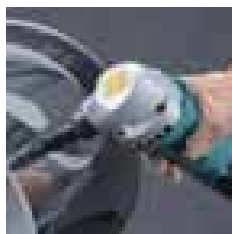
411 

Prikon	550W
Max. rezný výkon	Oceľ do 400 N/mm ² : 1,6 mm Oceľ do 600 N/mm ² : 1,2 mm Oceľ do 800 N/mm ² : 0,8 mm Hliník do 200 N/mm ² : 2,5 mm
Min. rádius	Vonkajší obvod: 50 mm Vnútorný obvod: 45 mm
Počet strihov za minútu	2.200
Celková dĺžka	261 mm
Hmotnosť	1,6 kg
Dĺžka privodného kábla	2,0 m

JN1601
399,90 €

Prestrihovač

JN3201 3,2 mm

303 

Prikon	710W
Max. rezný výkon	Oceľ do 400 N/mm ² : 3,2 mm Oceľ do 600 N/mm ² : 2,5 mm Oceľ do 800 N/mm ² : 1,0 mm Hliník do 200 N/mm ² : 3,5 mm
Min. rádius	Vonkajší obvod: 128 mm Vnútorný obvod: 120 mm
Počet strihov za minútu	1.300
Rozmery	225×90×254 mm
Hmotnosť	3,4 kg
Dĺžka privodného kábla	2,5 m

JN3201J
599,90 €

Rezač hliníkových profilov











CA5000 118 mm

303 

Prikon	1.300W
Rezný kotúč	Rezný kotúč / TCT kotúč
Max. rezný výkon s rezným kotúčom	S lístou: 11 mm
Max. rezný výkon s TCT kotúčom	S lístou: 36 mm Bez lísty: 41 mm
Voľnobežné otáčky	2.200 – 6.400
Rozmery	346×250×250 mm
Hmotnosť	4,7 kg
Dĺžka privodného kábla	2,5 m

CA5000XJ
599,90 €



▣ BRÚSENIE / LEŠTENIE

-  Dvojitá izolácia
-  Nastavenie otáčok
-  Brzda
-  El. nastavenie otáčok /2 rýchlosti/
-  Obmedzovač momentu
-  Konštantné otáčky
-  Obmedzovač rozbehového prúdu
-  Hák / klip
-  Odsávanie prachu
-  Zabudované osvetlenie
-  Prepravný kufor

Uhlová brúska

GA5021C / GA6021C Anti-restart, plynulý rozbeh, veľký vypínač

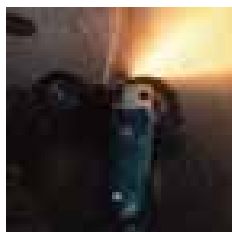
253



	GA5021C	GA6021C
Príkon	1.450W	1.450W
Priemer kotúča	125 mm	150 mm
Voľnobežné otáčky	10.000	9.000
Vibrácie	Plošné brúsenie: 8,5 m/s ² Brúsenie kotúčom: 2,5 m/s ²	Plošné brúsenie: 8,5 m/s ² Brúsenie kotúčom: 2,5 m/s ²
Úroveň akustického tlaku	90 dB(A)	90 dB(A)
Úroveň akustického výkonu	101 dB(A)	101 dB(A)
Rozmery	390×139×120 mm	390×169×120 mm
Hmotnosť	2,9 – 4,1 kg	3,0 – 3,5 kg
Dĺžka privodného kábla	2,5 m	2,5 m

GA5021C
179,90 €GA6021C
192,90 €

Uhlová brúska

GA5041C SJS II, regulácia otáčok, Anti-restart, mechanická brzda, plynulý rozbeh, posuvný vypínač

318



Príkon	1.400W
Priemer kotúča	125 mm
Voľnobežné otáčky	2.800 – 11.000
Vibrácie	
Plošné brúsenie s antivibračnou rukoväťou:	6,0 m/s ²
Brúsenie kotúčom s antivibračnou rukoväťou:	2,5 m/s ²
Úroveň akustického tlaku	84 dB(A)
Úroveň akustického výkonu	95 dB(A)
Rozmery	325×140×121 mm
Hmotnosť	2,7 – 3,8 kg
Dĺžka privodného kábla	2,5 m

GA5041C01
199,90 €

01 – antivibračná rukoväť

Uhlová brúska

GA6040C SJS II, regulácia otáčok, Anti-restart, plynulý rozbeh, posuvný vypínač

318

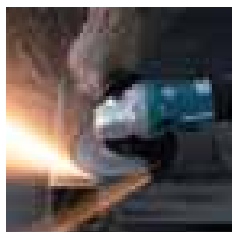

Príkon	1.400W
Priemer kotúča	150 mm
Voľnobežné otáčky	4.000 – 9.000
Vibrácie	
Plošné brúsenie s antivibračnou rukoväťou:	6,0 m/s ²
Brúsenie kotúčom s antivibračnou rukoväťou:	2,5 m/s ²
Úroveň akustického tlaku	87 dB(A)
Úroveň akustického výkonu	98 dB(A)
Rozmery	303×171×116 mm
Hmotnosť	2,5 – 2,9 kg
Dĺžka privodného kábla	2,5 m

GA6040C01
169,90 €

01 – antivibračná rukoväť

Uhlová brúska

9565CVR SJS, regulácia otáčok, Anti-restart, plynulý rozbeh, posuvný vypínač

318

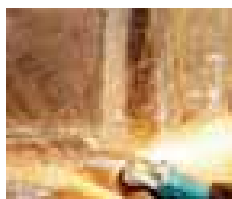

Príkon	1.400W
Priemer kotúča	125 mm
Voľnobežné otáčky	2.800 – 12.000
Rozmery	299×139×103 mm
Hmotnosť	2,5 – 3,6 kg
Dĺžka privodného kábla	2,4 – 3,5 kg

9565CVR
139,90 €

Uhlová brúska

9565CR SJS, Anti-restart, plynulý rozbeh, posuvný vypínač

318



Príkon	1.400W
Priemer kotúča	125 mm
Voľnobežné otáčky	12.000
Vibrácie	
Plošné brúsenie s antivibračnou rukoväťou:	7,5 m/s ²
Brúsenie kotúčom:	2,5 m/s ²
Úroveň akustického tlaku	82 dB(A)
Úroveň akustického výkonu	93 dB(A)
Rozmery	299×139×103 mm
Hmotnosť	2,4 – 3,5 kg
Dĺžka privodného kábla	2,5 m

9565CR
129,90 €

Uhlová brúska

GA5040R SJS II, Anti-restart, plynulý rozbeh, posuvný vypínač

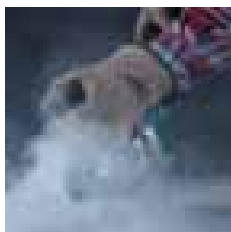
325 

Prikon	1.100W
Priemer kotúča	125 mm
Voľnobežné otáčky	11.000
Vibrácie	
Plošné brúsenie s antivibračnou rukoväťou:	6,0 m/s ²
Brúsenie kotúčom:	2,5 m/s ²
Úroveň akustického tlaku	86 dB(A)
Úroveň akustického výkonu	97 dB(A)
Rozmery	303×140×116 mm
Hmotnosť	2,5 – 3,6 kg
Dĺžka prívodného kábla	2,5 m

GA5040R
119,90 €GA5040RZ1
119,90 €

Uhlová brúska

GA6021 SJS, veľký vypínač

303 

Prikon	1.050W
Priemer kotúča	150 mm
Voľnobežné otáčky	10.000
Vibrácie	
Plošné brúsenie:	6,5 m/s ²
Brúsenie kotúčom:	2,5 m/s ²
Úroveň akustického tlaku	89 dB(A)
Úroveň akustického výkonu	100 dB(A)
Rozmery	384×172×120 mm
Hmotnosť	2,8 – 3,2 kg
Dĺžka prívodného kábla	2,5 m

GA6021
149,90 €

Uhlová brúska

9557HNR / 9558HNR Anti-restart, plynulý rozbeh, posuvný vypínač

325 

Prikon	840W	840W
Priemer kotúča	115 mm	125 mm
Voľnobežné otáčky	11.000	11.000
Vibrácie		
Plošné brúsenie:	7,5 m/s ²	8,5 m/s ²
Brúsenie kotúčom:	2,5 m/s ²	2,5 m/s ²
Úroveň akustického tlaku	86 dB(A)	86 dB(A)
Úroveň akustického výkonu	97 dB(A)	97 dB(A)
Rozmery	271×130×106 mm	271×140×106 mm
Hmotnosť	1,7 – 2,4 kg	1,7 – 3,2 kg
Dĺžka prívodného kábla	2,5 m	2,5 m

9557HNRG
79,90 €9558HNRG
84,90 €9558HNRGK
94,90 €9558HNRX1
99,90 €

X1 – 5 ks rezný kotúč 125 × 0,8 mm

Uhlová brúska

GA4530R / GA5030R Anti-restart, plynulý rozbeh, posuvný vypínač

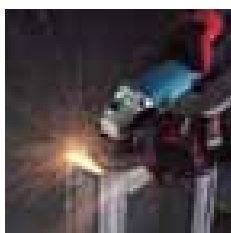
459 

Prikon	720W	720W
Priemer kotúča	115 mm	125 mm
Voľnobežné otáčky	11.000	11.000
Vibrácie		
Plošné brúsenie:	7,5 m/s ²	8,5 m/s ²
Brúsenie kotúčom:	2,5 m/s ²	2,5 m/s ²
Úroveň akustického tlaku	85 dB(A)	85 dB(A)
Úroveň akustického výkonu	96 dB(A)	96 dB(A)
Rozmery	266×130×108 mm	266×140×108 mm
Hmotnosť	1,88 – 2,22 kg	1,91 – 3,06 kg
Dĺžka prívodného kábla	2,5 m	2,5 m

GA4530R
59,90 €GA5030R
67,90 €GA5030RSP4
119,90 €GA5030RX1
75,90 €

SP4 – 4 ks lamelový kotúč, 1 ks diamantový kotúč, šiltovka; X1 – 5 ks rezný kotúč 125 × 0,8 mm

Uhlová brúska

GA9040R Anti-restart, plynulý rozbeh, veľký vypínač

204 

Prikon	2.600W
Priemer kotúča	230 mm
Voľnobežné otáčky	6.600
Vibrácie	
Plošné brúsenie:	6,0 m/s ²
Brúsenie kotúčom:	2,5 m/s ²
Úroveň akustického tlaku	90 dB(A)
Úroveň akustického výkonu	101 dB(A)
Rozmery	503×250×140 mm
Hmotnosť	6,69 – 8,98 kg
Dĺžka prívodného kábla	2,5 m

GA9040R
189,90 €GA9040RF01
199,90 €

R01 – antivibračná rukoväť

Uhlová brúska

GA9030 Veľký vypínač

204 

Príkon	2.400W
Priemer kotúča	230 mm
Voľnobežné otáčky	6.600
Vibrácie	Plošné brúsenie: 6,5 m/s ² Brúsenie kotúčom: 2,5 m/s ²
Úroveň akustického tlaku	90 dB(A)
Úroveň akustického výkonu	101 dB(A)
Rozmery	503x250x140 mm
Hmotnosť	6,26 – 8,55 kg
Dĺžka privodného kábla	2,5 m

GA9030X01
149,90 €

X01 – antivibračná rukoväť

Uhlová brúska

GA9063R D-rukoväť, SJS II, Anti-restart, plynulý rozbeh, veľký vypínač

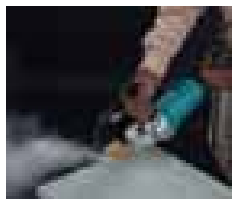
218 

Príkon	2.200W
Priemer kotúča	230 mm
Voľnobežné otáčky	6.600
Vibrácie	Plošné brúsenie s antivibračnou rukoväťou: 5,5 m/s ² Brúsenie kotúčom s antivibračnou rukoväťou: 2,5 m/s ²
Úroveň akustického tlaku	91 dB(A)
Úroveň akustického výkonu	102 dB(A)
Rozmery	450x250x145 mm
Hmotnosť	5,80 – 8,16 kg
Dĺžka privodného kábla	2,5 m

SJS II
SUPER JOINT SYSTEMGA9063R
199,90 €

Uhlová brúska

GA9062R D-rukoväť, Anti-restart, plynulý rozbeh, veľký vypínač

218 

Príkon	2.200W
Priemer kotúča	230 mm
Voľnobežné otáčky	6.600
Vibrácie	Plošné brúsenie s antivibračnou rukoväťou: 6,0 m/s ² Brúsenie kotúčom s antivibračnou rukoväťou: 2,5 m/s ²
Úroveň akustického tlaku	91 dB(A)
Úroveň akustického výkonu	102 dB(A)
Rozmery	450x250x144 mm
Hmotnosť	5,65 – 8,01 kg
Dĺžka privodného kábla	2,5 m (8,2 ft.)

GA9062R
179,90 €

Uhlová brúska

GA9060R Anti-restart, plynulý rozbeh, veľký vypínač

218 

Príkon	2.200W
Priemer kotúča	230 mm
Voľnobežné otáčky	6.600
Vibrácie	Plošné brúsenie s antivibračnou rukoväťou: 6,0 m/s ² Brúsenie kotúčom s antivibračnou rukoväťou: 2,5 m/s ²
Úroveň akustického tlaku	91 dB(A)
Úroveň akustického výkonu	102 dB(A)
Rozmery	450x250x144 mm
Hmotnosť	5,52 – 7,88 kg
Dĺžka privodného kábla	2,5 m

GA9060R
169,90 €

Uhlová brúska

GA9020R Anti-restart, plynulý rozbeh, veľký vypínač

204

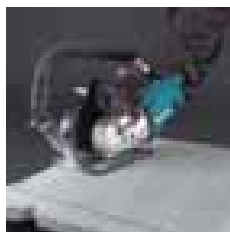

Prikon	2.200W
Priemer kotúča	230 mm
Voľnobežné otáčky	6.600
Vibrácie	Plošné brúsenie: 6,0 m/s ²
	Brúsenie kotúčom: 2,5 m/s ²
Úroveň akustického tlaku	90 dB(A)
Úroveň akustického výkonu	101 dB(A)
Rozmery	473×250×140 mm
Hmotnosť	5,80 – 8,09 kg
Dĺžka prívodného kábla	2,5 m



GA9020RF
159,90 €

GA9020RFK
179,90 €

Uhlová brúska

GA7020 / GA9020 Veľký vypínač

204

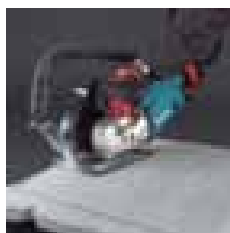

	GA7020	GA9020
Prikon	2.200W	2.200W
Priemer kotúča	180 mm	230 mm
Voľnobežné otáčky	8.500	6.000
Vibrácie		Plošné brúsenie: 5,5 m/s ²
Plošné brúsenie s antivibračnou rukoväťou:	8,0 m/s ²	
Brúsenie kotúčom:	2,5 m/s ²	2,5 m/s ²
Úroveň akustického tlaku	89 dB(A)	89 dB(A)
Úroveň akustického výkonu	100 dB(A)	100 dB(A)
Rozmery	473×200×140 mm	473×249×140 mm
Hmotnosť	5,56 – 6,06 kg	5,76 – 8,05 kg
Dĺžka prívodného kábla	2,5 m	2,5 m



GA7020
119,90 €

GA9020
129,90 €

GA9020K
149,90 €

Uhlová brúska

GA9050R Anti-restart, plynulý rozbeh, veľký vypínač

204

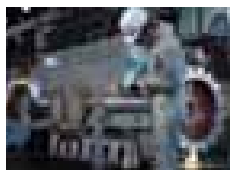

Prikon	2.000W
Priemer kotúča	230 mm
Voľnobežné otáčky	6.600
Vibrácie	Plošné brúsenie: 5,5 m/s ²
	Brúsenie kotúčom: 2,5 m/s ²
Úroveň akustického tlaku	94 dB(A)
Úroveň akustického výkonu	105 dB(A)
Rozmery	455×250×132 mm
Hmotnosť	4,82 – 7,12 kg
Dĺžka prívodného kábla	2,5 m



GA9050R
129,90 €

Uhlová brúska

GA7012C / GA9012C Anti-restart, plynulý rozbeh, veľký vypínač

204



	GA7012C	GA9012C
Prikon	1.800W	1.800W
Priemer kotúča	180 mm	230 mm
Voľnobežné otáčky	8.400	6.000
Vibrácie	Plošné brúsenie: 7,0 m/s ²	Plošné brúsenie: 6,0 m/s ²
	Brúsenie kotúčom: 3,5 m/s ²	Brúsenie kotúčom: 3,0 m/s ²
Úroveň akustického tlaku	90 dB(A)	90 dB(A)
Úroveň akustického výkonu	101 dB(A)	101 dB(A)
Rozmery	453×200×137 mm	453×250×137 mm
Hmotnosť	4,0 – 4,5 kg	4,37 – 6,66 kg
Dĺžka prívodného kábla	2,5 m	2,5 m



GA7012C
179,90 €

GA9012C
189,90 €

Leštička

SA7000C 180 mm

204



Prikon	1.600W
Abrasívna Disc Size	180 mm
Max. priemer padu	Pad: 180 mm
Voľnobežné otáčky	0 – 4.000
Rozmery	453×170×136 mm
Hmotnosť	3,5 – 3,6 kg
Dĺžka prívodného kábla	2,5 m



SA7000C
229,90 €

Leštička

SA5040C SJS II, Anti-restart, 125 mm

318 

Príkon	1.400W
Priemer kotúča	125 mm
Max. priemer padu	Pad: 115 mm
Voľnobežné otáčky	2.000 – 7.800
Rozmery	315×115×121 mm
Hmotnosť	2,5 – 3,7 kg
Dĺžka privodného kábla	2,5 m



SA5040C
199,90 €

Leštička

9237CB 180 mm

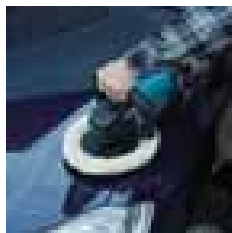
303 

Príkon	1.200W
Max. priemer padu	Vlnený pad: 180 mm
Voľnobežné otáčky	0 – 3.200
Vibrácie	2,5 m/s ²
Úroveň akustického tlaku	83 dB(A)
Úroveň akustického výkonu	94 dB(A)
Rozmery	431×198×187 mm
Hmotnosť	3,2 – 3,4 kg
Dĺžka privodného kábla	2,5 m



9237CB
299,90 €

Leštička

PO6000C 150 mm



Príkon	900W
Rozmer padu	150 mm
Excentrický vykyv za minútu	0 – 6.800
Počet strihov za minútu	0 – 13.600
Voľnobežné otáčky	0 – 780
Priemer vykyvu	5,5 mm
Vibrácie	Leštenie: 7,0 m/s ²
Úroveň akustického tlaku	83 dB(A)
Úroveň akustického výkonu	94 dB(A)
Rozmery	451×148×126 mm
Hmotnosť	2,8 – 3,0 kg
Dĺžka privodného kábla	4,0 m



PO6000C
379,90 €

Leštička

PV7000C 180 mm

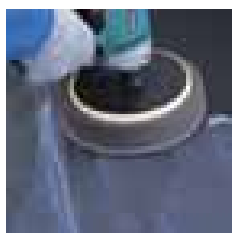
303 

Príkon	900W
Max. priemer padu	Pad: 180 mm
Voľnobežné otáčky	600 – 2.100
Vibrácie	Leštenie: 2,5 m/s ²
Úroveň akustického tlaku	81 dB(A)
Úroveň akustického výkonu	92 dB(A)
Celková dĺžka	210 mm
Hmotnosť	2,1 kg
Dĺžka privodného kábla	2,5 m



PV7000C
269,90 €

Leštička na kameň

PW5000CH

318 

Príkon	900W
Max. priemer padu	Pad: 100 – 125 mm
Voľnobežné otáčky	2.000 – 4.000
Celková dĺžka	313 mm
Hmotnosť	2,3 – 2,6 kg
Dĺžka privodného kábla	5,0 m

Ku stroju je potrebné dokúpiť transformátor P-67016



PW5000CH
369,90 €



SJS II

SUPER JOINT SYSTEM

Znižuje vibrácie

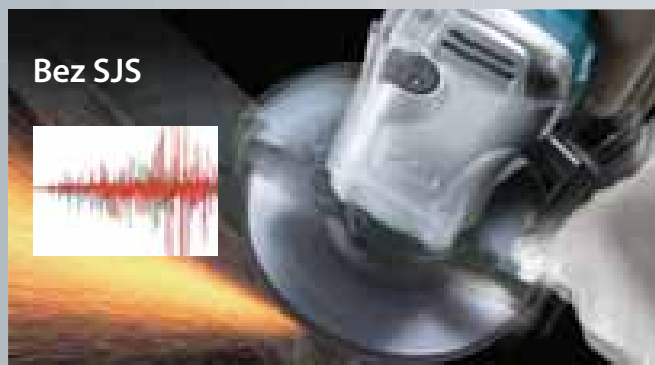

Super JointSystem II

Pružný krúžok absorbuje vibrácie.



Absorbovanie vibrácií



100mm	115mm	125mm	150mm	180mm	230mm	115mm, 125mm
GA4041C, GA4040C, GA4040	GA4541C, GA4543C, GA4540C, GA4542C, GA4541R, GA4541, GA4540R, GA4540	GA5041C, GA5043C, GA5040C, GA5042C, GA5041R, GA5041, GA5040R, GA5040	GA6040C, GA6042C, GA6040R, GA6040	GA7063, GA7063R, GA7061, GA7061R	GA9063, GA9063R, GA9061, GA9061R	SA4540C, SA4542C, SA5040C

Brúsenie / rezanie

Uhlové brúsky

Model				Príkon (W)	Vypínač	Antireštart	SJS	SJS2	Nastavenie otáčok	Brzda	Konštantná rýchlosť	Plynulý rozbeh
100mm	115mm	125mm	150mm									
		GA5021C	GA6021C	1 450W	Veľký vypínač	•	•				•	•
		GA5020C	GA6020C	1 450W	Malý vypínač	•	•				•	•
GA4041C	GA4541C	GA5041C		1 400W	Posuvný vypínač	•		•	•	•	•	•
GA4040C	GA4540C	GA5040C	GA6040C	1 400W	Posuvný vypínač	•		•	•		•	•
	GA4542C	GA5042C	GA6042C	1 400W	Posuvný vypínač			•	•		•	•
	GA4543C	GA5043C		1 400W	Posuvný vypínač			•	•	•	•	•
	9564CVR	9565CVR	9566CVR	1 400W	Posuvný vypínač	•	•		•		•	•
	9564CV	9565CV	9566CV	1 400W	Posuvný vypínač		•		•		•	•
	9564CR	9565CR	9566CR	1 400W	Posuvný vypínač	•	•				•	•
	9564C	9565C	9566C	1 400W	Posuvný vypínač		•				•	•
	9564PCV	9565PCV	9566PCV	1 400W	Pákový vypínač		•		•		•	•
	9564PC	9565PC	9566PC	1 400W	Pákový vypínač		•				•	•
		9565CVL / 9565CLR		1 400W	Posuvný vypínač	-/•	•		•		•	•
	9561CR / 9561CVR			1 200W	Posuvný vypínač	•	•		-/•		•	•
	GA4541R	GA5041R		1 100W	Posuvný vypínač	•		•		•		
	GA4541	GA5041		1 100W	Posuvný vypínač			•		•		
	GA4540R	GA5040R	GA6040R	1 100W	Posuvný vypínač	•		•				•
	GA4540R	GA5040R	GA6040R	1 100W	Posuvný vypínač	•		•				•
	9564HR	9565HR		1 100W	Posuvný vypínač	•	•					•
9563H	9564H	9565H		1 100W	Posuvný vypínač		•					
	9564P	9565P		1 100W	Pákový vypínač		•					
		GA5011 / GA5021	GA6021	1 050W	Veľký vypínač		•					
		GA5010 / GA5020	GA6010 / GA6020	1 050W	Malý vypínač		-/•					
9556NB / 9556HN	9557HN	9558HN		840W	Posuvný vypínač							
	9557NBR / 9557HNR	9558NBR / 9558HNR		840W	Posuvný vypínač	•						•
9556PB / 9556HP	9557PB / 9557HP	9558PB / 9558HP		840W	Pákový vypínač							
9556HB				840W	Prepínač							
GA4031 / GA4032				720W	Prepínač							
GA4030R	GA4530R	GA5030R		720W	Posuvný vypínač	•						•
GA4030t	GA4530	GA5030t		720W	Posuvný vypínač							
GA4034	GA4534	GA5034		720W	Pákový vypínač							
9553HN	9554HN	9555HN		710W	Posuvný vypínač							
9553B / 9553HB		9555B		710W	Prepínač							
9500NB / N9500N				570W	Prepínač							

Model		Príkon (W)	Vypínač	Antireštart	Konštantná rýchlosť	SJS2	Obmedzovač momentu	Plynulý rozbeh
180mm	230mm							
GA7040R	GA9040R	2 600W	Veľký vypínač	•			•	•
GA7040S	GA9040S / GA9040	2 600W	Veľký vypínač				•	•/-
GA7030R	GA9030R	2 400W	Veľký vypínač	•			•	•
GA7030S / GA7030	GA9030S / GA9030	2 400W	Veľký vypínač				•	•/-
GA7031	GA9031	2 400W	AC / DC vypínač				•	
GA7061R / GA7063R	GA9061R / GA9063R	2 200W	Veľký vypínač	•		•		•
GA7061 / GA7063	GA9061 / GA9063	2 200W	Veľký vypínač			•		
GA7061R / GA7063R	GA9061R / GA9063R	2 200W	Veľký vypínač	•				•
GA7060 / GA7062 / GA7064	GA9060 / GA9062	2 200W	Veľký vypínač					
GA7020R	GA9020R	2 200W	Veľký vypínač	•				•
GA7020S	GA9020S	2 200W	Veľký vypínač					•
GA7020 / GA7021	GA9020	2 200W	Veľký vypínač					
GA7050R	GA9050R	2 000W	Veľký vypínač	•				•
GA7050	GA9050	2 000W	Veľký vypínač					
GA7012C	GA9012C	1 800W	Veľký vypínač	•	•			•
GA7010C	GA9010C	1 800W	Veľký vypínač		•			•

Brúška na betón

PC5000C

253 

Prikon	1.400W
Priemer kotúča	125 mm
Vŕtanie brúsneho kotúča	22,23 mm
Voľnobežné otáčky	10.000
Rozmery	437×235×195 mm
Hmotnosť	4 kg
Dĺžka privodného kábla	5,0 m

PC5000C
399,90 €

Brúška na betón

PC5010C

NOVINKA

253 

Prikon	1.400W
Priemer kotúča	125 mm
Vŕtanie brúsneho kotúča	22,23 mm
Voľnobežné otáčky	4.000 – 9.000
Rozmery	350×231×179 mm
Hmotnosť	2,5 – 3,6 kg
Dĺžka privodného kábla	4,0 m

PC5010C
329,90 €

Priama brúška

GD0603 6 mm

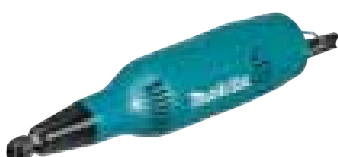
64 

Prikon	240W
Uchytenie nástroja	Klieština: 6 mm
Max. priemer brúsneho nástroja	19 mm
Voľnobežné otáčky	28.000
Priemer rukoväti	65 mm
Rozmery	289×64×67 mm
Hmotnosť	0,98 kg
Dĺžka privodného kábla	2,5 m

GD0603
79,90 €

Priama brúška

GD0601 6 mm

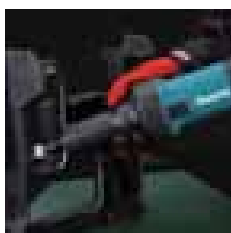
325 

Prikon	400W
Uchytenie nástroja	Klieština: 3, 6 mm
Priemer kotúča	38 mm
Voľnobežné otáčky	25.000
Rozmery	359×82×82 mm
Hmotnosť	1,68 – 1,84 kg
Dĺžka privodného kábla	2,5 m

GD0601
89,90 €

Priama brúška

GD0801C 8 mm

318 

Prikon	750W
Uchytenie nástroja	Klieština: 8 mm
Max. priemer brúsneho nástroja	25 mm
Voľnobežné otáčky	7.000 – 29.000
Vibrácie	Plošné brúsenie: 3,5 m/s ²
Úroveň akustického tlaku	80 dB(A)
Úroveň akustického výkonu	91 dB(A)
Rozmery	390×75×88 mm
Hmotnosť	1,96 – 1,97 kg
Dĺžka privodného kábla	2,5 m

GD0801C
299,90 €

Stroj je dodávaný bez brúsneho nástroja



Priama brúska

GD0800C 8 mm

318 

Stroj je dodávaný bez brúsneho nástroja



Príkon	750W
Uchytenie nástroja	Klieština: 3, 6, 8 mm
Priemer kotúča	25 mm
Voľnobežné otáčky	7.000 – 28.000
Rozmery	371×75×75 mm
Hmotnosť	1,88 kg
Dĺžka privodného kábla	2,5 m

GD0800C
279,90 €

Priama brúska

GD0810C 8 mm

318 

Stroj je dodávaný bez brúsneho nástroja



Príkon	750W
Uchytenie nástroja	Klieština: 3, 6, 8 mm
Priemer kotúča	50 mm
Voľnobežné otáčky	1.800 – 7.000
Celková dĺžka	371 mm
Hmotnosť	1,9 kg
Dĺžka privodného kábla	2,5 m

GD0810C
289,90 €

Priama brúska

GS5000 125 mm

204 

Príkon	750W
Priemer kotúča	125 mm
Vŕtanie kotúča	12,7, 20 mm
Voľnobežné otáčky / min ⁻¹	5.600
Rozmery	590×189×116 mm
Hmotnosť	5,0 – 5,2 kg
Dĺžka privodného kábla	2,5 m

GS5000
329,90 €

Multifunkčné náradie

TM3010C

459 

Príkon	320W
Počet strihov za minútu	6.000 – 20.000
Rozmery	283×68×87 mm
Hmotnosť	1,6 – 1,7 kg
Dĺžka privodného kábla	2,5 m

TM3010C
149,90 €
TM3010CX5J
239,90 €

X5 – sada príslušenstva

Kotúčová brúska

GB602 150 mm



Príkon	250W
Priemer kotúča	150 mm
Hrúbka kotúča	16 mm
Vŕtanie brúsneho kotúča	12,7 mm
Voľnobežné otáčky	2.850 (50 Hz) / 3.450 (60 Hz)
Úroveň akustického tlaku	74 dB(A)
Rozmery	375×205×286 mm
Hmotnosť	9,31 – 9,08 kg

GB602
129,90 €

Kotúčová brúska

GB602W 150 mm



Prikon	250W
Priemer kotúča	150 mm
Hrúbka kotúča	6,4 mm / 16 mm
Vŕtanie brúsneho kotúča	12,7 mm
Voľnobežné otáčky	2.850 (50 Hz) / 3.450 (60 Hz)
Úroveň akustického tlaku	75 dB(A)
Rozmery	375×348×286 mm
Hmotnosť	9,27 – 8,93 kg

GB602W
139,90 €

W – nadstavec na brúsenie kotúčov

Kotúčová brúska

GB801 205 mm

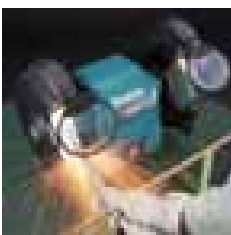

Prikon	550W
Priemer kotúča	205 mm
Hrúbka kotúča	19 mm
Vŕtanie brúsneho kotúča	15,88 mm
Voľnobežné otáčky	2.850 (50 Hz) / 3.450 (60 Hz)
Úroveň akustického tlaku	77 dB(A)
Rozmery	395×265×333 mm
Hmotnosť	19,91 – 19,63 kg

GB801
219,90 €

Pásová brúska

9032 9 mm × 533 mm

411



Prikon	500W
Rozmer brúsneho pásu	9×533 mm
Rychlosť brúsneho pásu	300 – 1.700 m/min
Max. hĺbka brúsenia	110 mm
Celková dĺžka	420 mm
Hmotnosť	1,6 kg
Dĺžka privodného kábla	2,5 m

9032
219,90 €

Pásová brúska

9031 30 mm × 533 mm

411



Prikon	550W
Rozmer brúsneho pásu	30×533 mm
Rychlosť brúsneho pásu	200 – 1.000 m/min
Celková dĺžka	380 mm
Hmotnosť	2,1 kg
Dĺžka privodného kábla	2,5 m

9031
279,90 €

Pásová brúska

9911 / 9910 76 mm × 457 mm

411

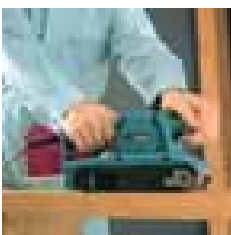
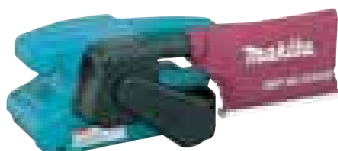

9911

	9911	9910
Prikon	650W	650W
Rozmer brúsneho pásu	76×457 mm	76×457 mm
Rychlosť brúsneho pásu	75 – 270 m/min	270 m/min
Celková dĺžka	262 mm	262 mm
Hmotnosť	2,7 kg	2,7 kg
Dĺžka privodného kábla	2,5 m	2,5 m

9911
154,90 €

9910
139,90 €

Pásová brúska

9903 76 mm × 533 mm

303 

Príkon	1,010W
Rozmer brúsneho pásu	76×533 mm
Rýchlosť brúsneho pásu	210 – 440 m/min
Celková dĺžka	296 mm
Hmotnosť	4,3 kg
Dĺžka privodného kábla	5,0 m

9903
289,90 €

Pásová brúska

9924DB 76 mm × 610 mm

100 

Príkon	850W
Rozmer brúsneho pásu	76×610, 620 mm
Rýchlosť brúsneho pásu	400 m/min
Celková dĺžka	355 mm
Hmotnosť	4,8 kg
Dĺžka privodného kábla	5,0 m

9924DB
289,90 €

Pásová brúska

9403 100 mm × 610 mm

303 

Príkon	1,200W
Rozmer brúsneho pásu	100×610 mm
Rýchlosť brúsneho pásu	500 m/min
Celková dĺžka	353 mm
Hmotnosť	5,7 kg
Dĺžka privodného kábla	5,0 m

9403J
329,90 €

Pásová brúska

9404 100 mm × 610 mm

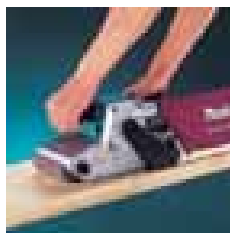
303 

Príkon	1,010W
Rozmer brúsneho pásu	100×610 mm
Rýchlosť brúsneho pásu	210 – 440 m/min
Celková dĺžka	334 mm
Hmotnosť	4,8 kg
Dĺžka privodného kábla	5,0 m

9404J
333,90 €

Kefová brúska

9741

100 

Príkon	860W
Priemer kotúča	100×120 mm
Voľnoběžné otáčky	3.500
Celková dĺžka	310 mm
Hmotnosť	4,2 kg
Dĺžka privodného kábla	5,0 m

9741
499,90 €

Vibračná brúska

BO3711 / BO3710

64 



	BO3711	BO3710
Prikon	190W	190W
Rozmer padu	93×185 mm	93×185 mm
Rozmer brúsneho papiera	93×228 mm	93×228 mm
Excentrický výkyv za minútu	4.000 – 11.000	11.000
Počet strihov za minútu	8.000 – 22.000	22.000
Priemer výkyvu	2,0 mm	2,0 mm
Vibrácie	Brúsenie železnej platne: 3,5 m/s ²	Brúsenie železnej platne: 3,5 m/s ²
Úroveň akustického tlaku	72 dB(A)	72 dB(A)
Rozmery	253×92×154 mm	253×92×154 mm
Hmotnosť	1,6 kg	1,6 kg
Dĺžka privodného kábla	2,0 m	2,0 m



BO3711

BO3711
92,90 €

BO3710
79,90 €

Vibračná brúska

BO4900V

419 



Prikon	330W
Rozmer padu	115×229 mm
Rozmer brúsneho papiera	115×232 mm
Excentrický výkyv za minútu	4.000 – 10.000
Celková dĺžka	289 mm
Hmotnosť	2,9 kg
Dĺžka privodného kábla	2,5 m



BO4900VJ
279,90 €

Vibračná brúska

9046

419 

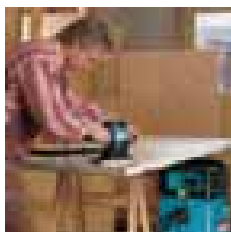

Prikon	600W
Rozmer padu	115×229 mm
Rozmer brúsneho papiera	115×280 mm
Excentrický výkyv za minútu	6.000
Celková dĺžka	283 mm
Priemer výkyvu	5 mm
Hmotnosť	3,1 kg
Dĺžka privodného kábla	2,5 m



9046
249,90 €

Vibračná brúska

BO4555

419 



Prikon	200W
Rozmer padu	112×102 mm
Rozmer brúsneho papiera	114×102 mm
Excentrický výkyv za minútu	14.000
Celková dĺžka	131×112×141 mm
Hmotnosť	1,1 kg
Dĺžka privodného kábla	2,0 m



BO4555
79,90 €

Vibračná brúska

BO4565

419 



Prikon	200W
Rozmer padu	112×190 mm
Rozmer brúsneho papiera	114×102 mm
Trojuholník	96 mm
Excentrický výkyv za minútu	14.000
Rozmery	219×112×139 mm
Hmotnosť	1,2 kg
Dĺžka privodného kábla	2,0 m



BO4565K
84,90 €

Vibračná brúška

BO4557

419 

Príkon	180W
Rozmer padu	112x102 mm
Rozmer brúsneho papiera	114x140 mm
Excentrický vykyv za minútu	14.000
Rozmery	131x112x137 mm
Hmotnosť	1 kg
Dĺžka privodného kábla	2,0 m

BO4557
59,90 €

Excentrická brúška

BO5031 / BO5030

419 

BO5031

BO5031

BO5030

	BO5031	BO5030
Príkon	300W	300W
Priemer padu	123 mm	123 mm
Priemer brúsneho kotúča	125 mm	125 mm
Excentrický vykyv za minútu	4.000 – 12.000	12.000
Rozmery	153x123x153 mm	153x123x153 mm
Hmotnosť	1,3 kg	1,3 kg
Dĺžka privodného kábla	2,0 m	2,0 m

BO5031
129,90 €
BO5030
109,90 €

Excentrická brúška

BO5041

64 

Príkon	300W
Rozmer padu	123 mm
Rozmer brúsneho papiera	125 mm
Excentrický vykyv za minútu	4.000 – 12.000
Rozmery	218x123x153 mm
Hmotnosť	1,4 kg
Dĺžka privodného kábla	2,0 m

BO5041
149,90 €

Excentrická brúška

BO6030

419 

Príkon	310W
Rozmer padu	150 mm
Rozmer brúsneho papiera	150 mm
Excentrický vykyv za minútu	4.000 – 10.000
Celková dĺžka	309 mm
Priemer vykyvu	3,0 mm
Hmotnosť	2,4 kg
Dĺžka privodného kábla	2,5 m

BO6030
199,90 €

Excentrická brúška

BO6050

















326 

Príkon	750W
Rozmer padu / brúsneho papiera	150 mm / 150 mm
Excentrický vykyv za minútu	1.600 – 6.800
Počet kmitov za minútu	3.200 – 13.600
Rýchlosť padu v roto-orbit móde	140 – 600
Priemer vykyvu	5,5 mm
Vibrácie	Sanding Metal Plate: 5,0 m/s ² Leštenie: 3,0 m/s ²
Úroveň akustického tlaku	82 dB(A)
Úroveň akustického výkonu	93 dB(A)
Rozmery	330x155x145 mm
Hmotnosť	2,6 kg
Dĺžka privodného kábla	2,5 m

BO6050J
399,90 €

▣ PÍLENIE



-  Dvojitá izolácia
-  Nastavenie otáčok
-  Brzda
-  Mechanické nastavenie otáčok /2 rýchlosti/
-  Konštantné otáčky
-  Obmedzovač rozbehového prúdu
-  Rez pod uhlom 45 LR
-  Rez pod uhlom L45 R5
-  Rez pod uhlom 45 vľavo
-  Rez v oblúku
-  Makita uchytenie nástroja
-  Bajonetové upínanie
-  Laser
-  Odsávanie prachu
-  Zabudované osvetlenie
-  Prepravný kufr

Pokosová píla

LS1219L 305 mm

153 

Príkon	1.800W
Priemer rezného kotúča	305 mm
Max. uhol pokosu	60° L / 60° R
Max. uhol úkosu	48° L / 48° R
Max. rezný výkon	90°: 107×363 mm 45°: 107×255 mm
Voľnoběžné otáčky	3.200
Rozmery	898×644×725 mm
Hmotnosť	LS1219L: 29,3 kg
Dĺžka privodného kábla	2,5 m

LS1219L
899,90 €

Pokosová píla

LS1019L 260 mm

153 

Príkon	1.510W
Priemer rezného kotúča	260 mm
Max. uhol pokosu	48° L / 48° R
Max. uhol úkosu	60° L / 60° R
Max. rezný výkon (pokos / úkos)	90°/90°: 68 / 310 mm 90°/90°: 91 / 279 mm 90°/45°LR: 68 / 218 mm 90°/45°LR: 91 / 197 mm
Voľnoběžné otáčky	3.200
Úroveň akustického tlaku	91 dB(A)
Úroveň akustického výkonu	101 dB(A)
Vibrácie	2,5 m/s ²
Rozmery	805×644×660 mm
Hmotnosť	LS1019L: 26,3 kg
Dĺžka privodného kábla	2,5 m

LS1019L
799,90 €

Pokosová píla

LS1018L 260 mm

JM23000123 

Príkon	1.430W
Priemer rezného kotúča	255 - 260 mm
Max. uhol pokosu	47° L / 60° R
Max. uhol úkosu	45° L / 45° R
Max. rezný výkon	90°: 91×305 mm 45°: 91×215 mm
Voľnoběžné otáčky	4.300
Úroveň akustického tlaku	97 dB(A)
Úroveň akustického výkonu	103 dB(A)
Vibrácie	2,5 m/s ²
Rozmery	825×536×633 mm
Hmotnosť	20,6 kg
Dĺžka privodného kábla	2,5 m

LS1018L
499,90 €

LS1018LN
499,90 €

Pokosová píla

LS0815FL 216 mm

JM23500117 

Príkon	1.400W
Priemer rezného kotúča	216 mm
Max. uhol pokosu	50° L / 60° R
Max. uhol úkosu	48° L / 5° R
Max. rezný výkon	90° Pokos: 65×305 mm 45° Pokos. L/R: 65×215 mm
Voľnoběžné otáčky	5.000
Úroveň akustického tlaku	87 dB(A)
Úroveň akustického výkonu	110 dB(A)
Vibrácie	2,5 m/s ²
Rozmery	755×450×488 mm
Hmotnosť	14,1 kg
Dĺžka privodného kábla	2,5 m

LS0815FL
349,90 €

LS0815FLN
349,90 €

Pokosová píla

LS0714 190 mm

153 

Príkon	1.010W
Priemer rezného kotúča	190 mm
Max. uhol pokosu	47° L / 57° R
Max. uhol úkosu	45° L / 5° R
Max. rezný výkon	90°: 52×300 mm 45°: 52×212 mm
Voľnoběžné otáčky	6.000
Úroveň akustického tlaku	92 dB(A)
Úroveň akustického výkonu	101 dB(A)
Vibrácie	2,5 m/s ²
Rozmery	670×430×458 mm
Hmotnosť	13,1 kg
Dĺžka privodného kábla	2,5 m

LS0714N
469,90 €

DXT
Deep and Exact Cutting Technology

Pokosová píla

LS1040 260 mm

153 



Prikon	1.650W
Priemer rezného kotúča	260 mm
Max. uhol pokosu	45° L / 52° R
Max. uhol úkosu	45° L
Max. rezný výkon	90°: 90,5×95 mm 45°: 90,5×67 mm
Voľnobežné otáčky / min ⁻¹	4.600
Úroveň akustického tlaku	93 dB(A)
Úroveň akustického výkonu	106 dB(A)
Rozmery	530×476×532 mm
Hmotnosť	12,4 kg
Dĺžka privodného kábla	2,5 m

LS1040N
279,90 €

Pokosová píla s vrchným stolom

LH1201FL 305 mm

JM23000123 



Prikon	1.650W
Priemer rezného kotúča	305 mm
Max. uhol pokosu	47° L / 52° R
Max. uhol úkosu	45° L
Max. rezný výkon	90°: 62×200 mm 90°: 95×155 mm 90°: Table saw: 52 mm
Voľnobežné otáčky	3.800
Úroveň akustického tlaku	93 dB(A)
Úroveň akustického výkonu	106 dB(A)
Veľkosť stola	307×465 mm
Rozmery	610×535×692 mm
Hmotnosť	20,9 kg
Dĺžka privodného kábla	2,5 m

LH1201FL
599,90 €

stroj

LH1040 260 mm

153 



Prikon	1.650W
Max. rezný výkon	90°: 93×95 mm 45°: 53×95 mm
Priemer rezného kotúča	260 mm
Voľnobežné otáčky	4.800
Rozmery	530×476×535 mm
Hmotnosť	14,3 kg
Dĺžka privodného kábla	2,5 m

LH1040
449,90 €

Pokosová / stolová píla

LF1000 260 mm

153 

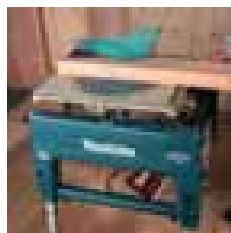

Prikon	1.650W
Max. rezný výkon	90°: 20×210 mm 90°: 68×155 mm 45°: 50×150 mm
Priemer rezného kotúča	260 mm
Voľnobežné otáčky	2.700
Rozmery	Pokosová píla: 660×650×1.220 mm Stolová píla: 660×650×1.060 mm
Hmotnosť	36,0 kg
Dĺžka privodného kábla	2,5 m

LF1000
999,90 €

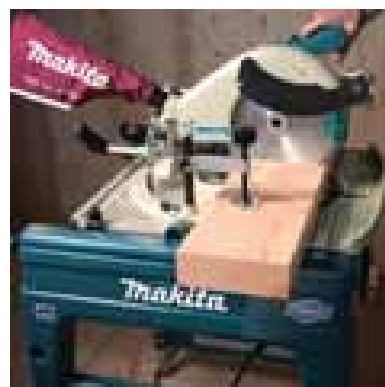

Stolová píla

2712 315 mm



Príkon	2.000W
Max. rezný výkon	90°: 85 mm
	45°: 58 mm
Priemer rezného kotúča	315 mm
Voľnobežné otáčky	50 Hz: 2.950
	60 Hz: 3.400
Max. rezný výkon /úkos/	0 - 45
Rozmery	1.670×700×810 mm
Hmotnosť	54 kg
Dĺžka privodného kábla	3,0 m

2712
459,90 €

Stolová píla

2704 260 mm

153

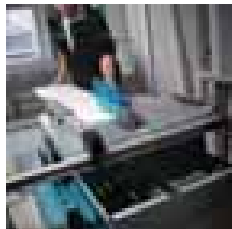
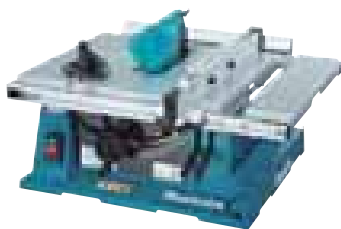

Príkon	1.650W
Max. rezný výkon	90°: 93 mm
	45°: 64 mm
Priemer rezného kotúča	260 mm
Voľnobežné otáčky	4.800
Max. rezný výkon /úkos/	- 0,5 - 45,5
Rozmery	665×766×344 mm
Hmotnosť	35,6 - 37,3 kg
Dĺžka privodného kábla	2,5 m

2704N
1 099,00 €

Stolová píla

MLT100 260 mm

JM23000123

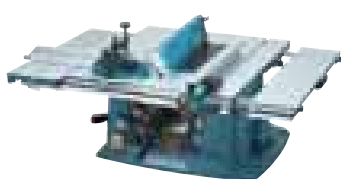

Príkon	1.500W
Max. rezný výkon	90°: 91 mm
	45°: 63 mm
Priemer rezného kotúča	260 mm
Voľnobežné otáčky	4.300
Rozmery	726×984×333 mm
Hmotnosť	34,1 kg
Dĺžka privodného kábla	2,5 m

MLT100
599,90 €

MLT100N
599,90 €

Pokosová píla

MLS100 255 mm

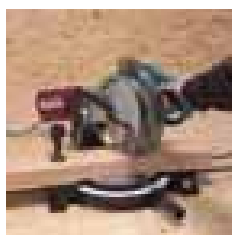

Príkon	1 500 W
Priemer rezného kotúča	255 mm
Max. uhol pokosu	75×130 mm
Max. uhol úkosu	75×90 mm
Voľnobežné otáčky / min ⁻¹	4 200
Hmotnosť	14,7 kg

MLS100
239,90 €

MLS100N
239,90 €

Kotúčová píla

HS6101 165 mm

174



Príkon	1.100W
Priemer rezného kotúča	165 mm
Max. rezný výkon	90°: 54,5 mm
	45°: 39,5 mm
	50°: 35,5 mm
Voľnobežné otáčky	5.500
Rozmery	297×246×246 mm
Hmotnosť	3,5 kg
Dĺžka privodného kábla	2,5 m

HS6101J
299,90 €

Kotúčová píla

HS6601 165 mm

303 



Prikon	1.050W
Priemer rezného kotúča	165 mm
Max. rezný výkon	90°: 54,5 mm
	45°: 37,5 mm
Voľnobežné otáčky	5.200
Vibrácie	Rezanie dreva
	2,5 m/s ²
Úroveň akustického tlaku	87 dB(A)
Úroveň akustického výkonu	98 dB(A)
Rozmery	296×232×243 mm
Hmotnosť	3,4 kg
Dĺžka privodného kábla	2,5 m



HS6601
129,90 €

HS6601J
159,90 €

Kotúčová píla

HS7611 185 mm / 190 mm





Prikon	1.600W
Priemer rezného kotúča	185 / 190 mm
Max. rezný výkon	90°: 63 / 65 mm
	45°: 44 / 45 mm
Voľnobežné otáčky	5.500
Rozmery	311×240×261 mm
Hmotnosť	3,9 kg
Dĺžka privodného kábla	2,5 m



HS7611J
189,90 €

Kotúčová píla

HS7101 / HS7100 190 mm

174 



Prikon	1.400W
Priemer rezného kotúča	190 mm
Max. rezný výkon	90°: 67 mm
	45°: 48,5 mm
	50°: 43,5 mm
Voľnobežné otáčky	5.500
Rozmery	310×246×258 mm
Hmotnosť	HS7101: 3,8 kg
	HS7100: 3,7 kg
Dĺžka privodného kábla	2,5 m



HS7101 HS7100

HS7101
259,90 €

HS7100
239,90 €

Kotúčová píla

HS7601 190 mm

303 



Prikon	1.200W
Priemer rezného kotúča	190 mm
Max. rezný výkon	90°: 66 mm
	45°: 46 mm
Voľnobežné otáčky	5.200
Rozmery	309×232×255 mm
Hmotnosť	3,8 kg
Dĺžka privodného kábla	2,5 m



HS7601
149,90 €

Kotúčová píla

5903R 235 mm

203 



Prikon	2.000W
Max. rezný výkon	90°: 85 mm
	45°: 64 mm
Priemer rezného kotúča	235 mm
Voľnobežné otáčky	4.500
Celková dĺžka	400 mm
Hmotnosť	7,2 kg
Dĺžka privodného kábla	2,5 m



5903R
299,90 €

Kotúčová píla

N5900B 235 mm

153 

Príkon	2.000W
Priemer rezného kotúča	235 mm
Max. rezný výkon	90°: 85 mm
	45°: 60 mm
	50°: 53 mm
Voľnobežné otáčky	4.100
Celková dĺžka	380 mm
Hmotnosť	6,8 kg
Dĺžka privodného kábla	2,5 m

N5900B
179,90 €

Kotúčová píla

5103R 270 mm

203 

Príkon	2.100W
Max. rezný výkon	90°: 100 mm
	45°: 73 mm
Priemer rezného kotúča	270 mm
Voľnobežné otáčky	3.800
Celková dĺžka	442 mm
Hmotnosť	9,3 kg
Dĺžka privodného kábla	2,5 m

5103R
559,90 €

Kotúčová píla

HS0600 260 mm / 270 mm

153 

Príkon	2.000W
Priemer rezného kotúča	260 / 270 mm
Max. rezný výkon	90°: 97 / 101 mm
	45°: 68 / 71 mm
	50°: 61 / 63 mm
Voľnobežné otáčky	4.300
Vibrácie	Rezanie dreva: 2,5 m/s ²
Úroveň akustického tlaku	94 dB(A)
Úroveň akustického výkonu	105 dB(A)
Rozmery	418×273×324 mm
Hmotnosť	6,9 kg
Dĺžka privodného kábla	2,5 m

HS0600
289,90 €

Kotúčová píla

5143R 355 mm

203 

Príkon	2.200W
Priemer rezného kotúča	355 mm
Max. rezný výkon	90°: 130 mm
	45°: 90 mm
Voľnobežné otáčky	2.700
Celková dĺžka	607 mm
Hmotnosť	12,5 kg
Dĺžka privodného kábla	5,0 m

5143R
849,90 €

Ponorná píla

SP6000 165 mm

303 

Príkon	1.300W
Priemer rezného kotúča	165 mm
Max. rezný výkon	90°: 56 mm
	45°: 40 mm
	48°: 38 mm
Voľnobežné otáčky	2.000 – 5.800
Rozmery	341×225×250 mm
Hmotnosť	4,1 kg
Dĺžka privodného kábla	2,5 m

SP6000J
379,90 €

Priamočiara píla

4350FCT

419 



Prikon	720W
Max. rezný výkon	Drevo: 135 mm Železo: 10 mm
Dĺžka kmitu	26 mm
Kmity / min	800 – 2.800
Rozmery	236×73×207 mm
Hmotnosť	2,7 kg
Dĺžka privodného kábla	2,5 m

4350FCTJ
229,90 €

Priamočiara píla

4351FCT

419 



Prikon	720W
Max. rezný výkon	Drevo: 135 mm Železo: 10 mm
Dĺžka kmitu	26 mm
Kmity / min	800 – 2.800
Rozmery	271×73×187 mm
Hmotnosť	2,6 kg
Dĺžka privodného kábla	2,5 m

4351FCTJ
219,90 €

Priamočiara píla

JV0600

64 



Prikon	650W
Max. rezný výkon	Drevo: 90 mm Železo: 10 mm
Dĺžka kmitu	23 mm
Kmity / min	500 – 3.100
Rozmery	236×77×199 mm
Hmotnosť	2,4 kg
Dĺžka privodného kábla	2,5 m

JV0600K
149,90 €

Priamočiara píla

4329

64 



Prikon	450W
Max. rezný výkon pri 90°	Drevo: 65 mm Železo: 6 mm
Dĺžka kmitu	18 mm
Kmity / min	500 – 3.100
Vibrácie	Rezanie dreva: 7,0 m/s ² Rezanie železných platní: 5,0 m/s ²
Úroveň akustického tlaku	83 dB(A)
Úroveň akustického výkonu	94 dB(A)
Rozmery	223×77×197 mm
Hmotnosť	1,9 kg
Dĺžka privodného kábla	2,0 m

4329
89,90 €

Priamočiara píla

4327 / 4326

64 



4327

	4327	4326
Prikon	450W	450W
Max. rezný výkon	Drevo: 65 mm Železo: 6 mm	Drevo: 65 mm Železo: 6 mm
Dĺžka kmitu	18 mm	18 mm
Kmity / min	500 – 3.100	3.100
Rozmery	224×77×197 mm	224×77×197 mm
Hmotnosť	1,9 kg	1,9 kg
Dĺžka privodného kábla	2,0 m	2,0 m

4327
79,90 €

4326
75,90 €

Chvostová píla

JR3050T

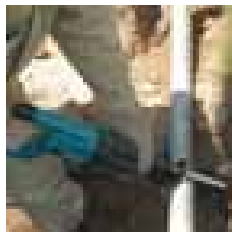
303 

Príkon	1,010W
Dĺžka kmitu	28 mm
Kmity / min	0 – 2.800
Max. rezný výkon	Rúra: 130 mm
	Drevo: 255 mm
Vibrácie	Drevené platne: 15,0 m/s ²
	Drevené hrady: 20,0 m/s ²
Úroveň akustického tlaku	89 dB(A)
Úroveň akustického výkonu	100 dB(A)
Celková dĺžka	452 mm
Hmotnosť	3,3 kg
Dĺžka privodného kábla	2,5 m



JR3050T
164,90 €

Chvostová píla

JR3060T

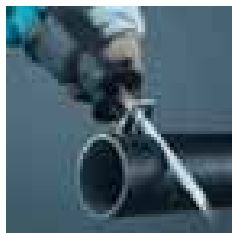
303 

Príkon	1,250W
Dĺžka kmitu	32 mm
Kmity / min	0 – 2.800
Max. rezný výkon	Rúra: 130 mm
	Drevo: 255 mm
Vibrácie	Drevené platne: 15,5 m/s ²
	Drevené hrady: 21,0 m/s ²
Úroveň akustického tlaku	87 dB(A)
Úroveň akustického výkonu	98 dB(A)
Celková dĺžka	485 mm
Hmotnosť	4,4 kg
Dĺžka privodného kábla	2,5 m



JR3060T
249,90 €

Chvostová píla

JR3070CT

303 

Príkon	1,510W
Dĺžka kmitu	32 mm
Kmity / min	0 – 2.800
Max. rezný výkon	Rúra: 130 mm
	Drevo: 255 mm
Vibrácie	Drevené platne: 9,5 m/s ²
	Drevené hrady: 10,5 m/s ²
Úroveň akustického tlaku	89 dB(A)
Úroveň akustického výkonu	100 dB(A)
Celková dĺžka	485 mm
Hmotnosť	4,6 kg
Dĺžka privodného kábla	2,5 m



JR3070CT
289,90 €

Pásová píla

LB1200F



Príkon	900W
Max. rezný výkon	Hrúbka rezu: 165 mm
Rýchlosť rezného pásu	Max.: (50 Hz)800 (60 Hz)1,000 m / min
	Min.: (50 Hz)400 (60 Hz)500 m / min
Rozmery	615x775x1.600 mm
Hmotnosť	82 kg
Dĺžka privodného kábla	2,5 m











LB1200F
799,90 €



AVT
ANTI VIBRATION TECHNOLOGY

▣ HOBĽOVANIE / FRÉZOVANIE



-  Dvojitá izolácia
-  Nastavenie otáčok
-  Brzda
-  Konštantné otáčky
-  Obmedzovač rozbehového prúdu
-  Odsávanie prachu
-  Zabudované osvetlenie
-  Drevený prepravný kufor
-  Prepravný kufor

Hoblík

1806B 170 mm



Príkon	1.200 W
Šírka noža	170 mm
Max. hĺbka	0 – 2 mm
Voľnobežné otáčky	15.000
Rozmery	530×240×150 mm
Hmotnosť	9 kg



1806B
649,90 €

Hoblík

KP0810C 82 mm

132



Príkon	1.050W
Šírka noža	82 mm
Max. hĺbka	4 mm
Max. drážka	25 mm
Voľnobežné otáčky	12.000
Rozmery	290×168×176 mm
Hmotnosť	3,4 kg
Dĺžka privodného kábla	2,5 m



KP0810C
299,90 €

Hoblík

KP0810 82 mm

132



Príkon	850W
Šírka noža	82 mm
Max. hĺbka	4 mm
Max. drážka	25 mm
Voľnobežné otáčky	16.000
Rozmery	290×168×176 mm
Hmotnosť	3,3 kg
Dĺžka privodného kábla	2,5 m



KP0810
264,90 €

Hoblík

KP0800 82 mm

411



Príkon	620W
Šírka noža	82 mm
Max. hĺbka	2,5 mm
Voľnobežné otáčky	17.000
Rozmery	285×158×158 mm
Hmotnosť	2,8 kg
Dĺžka privodného kábla	2,5 m



KP0800
139,90 €

Hoblík

N1923B 82 mm

51



Príkon	600W
Šírka noža	82 mm
Max. hĺbka	1 mm
Max. drážka	23 mm
Voľnobežné otáčky	16.000
Celková dĺžka	293 mm
Hmotnosť	3,1 kg
Dĺžka privodného kábla	2,5 m



N1923B
229,90 €



Prikon	840W
Šírka noža	110 mm
Max. hĺbka	2 mm
Voľnobežné otáčky	16.000
Celková dĺžka	355 mm
Hmotnosť	4,1 kg
Dĺžka privodného kábla	5,0 m

1911B
279,90 €



Prikon	2.200W
Šírka noža	312 mm
Max. hĺbka	Rezná šírka 0 – 150 mm : 3,5 mm Rezná šírka 150 – 240 mm : 2,0 mm Rezná šírka 240 – 312 mm : 1,5 mm
Voľnobežné otáčky	12.000
Celková dĺžka	551 mm
Hmotnosť	18,4 kg
Dĺžka privodného kábla	10 m

KP312S
2 299,00 €



Prikon	1.650W
Šírka noža	304 mm
Max. hĺbka	Rezná šírka 0 – 150 mm : 3 mm Rezná šírka 150 – 240 mm : 1,5 mm
Max. rýchlosť hobľovania /min/	8,5 m
Veľkosť stola	304x771 mm
Voľnobežné otáčky	8.500
Rozmery	483x771x401 mm
Hmotnosť	27,1 – 27,6 kg
Dĺžka privodného kábla	2,5 m

2012NBX
899,90 €

X – stól

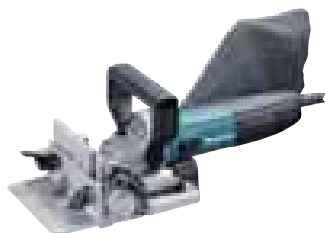

Prikon	701W
Priemer rezného kotúča	100 mm
Voľnobežné otáčky	11.000
Rozmery	302x139x145 mm
Hmotnosť	2,8 kg
Dĺžka privodného kábla	2,5 m

PJ7000J
329,90 €



Prikon	710W
Upinacia klieština	6 mm
Voľnobežné otáčky	10.000 – 30.000
Vibrácie	Bez záťaže: 2,5 m/s ² Rez drážok v MDF: 3,5 m/s ²
Úroveň akustického tlaku	82 dB(A)
Úroveň akustického výkonu	93 dB(A)
Rozmery	89x89x200 mm
Hmotnosť	1,8 – 2,7 kg
Dĺžka privodného kábla	2,5 m

RT0700C
139,90 €

RT0700CX2J
239,90 €

X2 – ponorný nadstavec, frézovací nadstavec

Jednoručná fréza

3709 6 mm

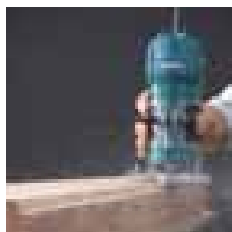
411 

Príkon	530W
Upínacia klieština	6 mm
Voľnobežné otáčky	30.000
Vibrácie	Bez záťaže: 2,5 m/s ²
Úroveň akustického tlaku	80 dB(A)
Rozmery	82×90×199 mm
Hmotnosť	1,5 kg
Dĺžka privodného kábla	2,5 m



3709
79,90 €

Jednoručná fréza

3710 6 mm

411 

Príkon	530W
Upínacia klieština	6 mm
Voľnobežné otáčky	30.000
Vibrácie	Bez záťaže: 2,5 m/s ²
Úroveň akustického tlaku	80 dB(A)
Rozmery	102×122×302 mm
Hmotnosť	1,5 kg
Dĺžka privodného kábla	2,5 m



3710
90,90 €

Horná fréza

RP1110C 8 mm

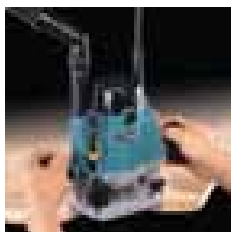
303 

Príkon	1.100W
Upínacia klieština	8 mm
Max. hĺbka ponoru	0 – 57 mm
Voľnobežné otáčky	8.000 – 24.000
Vibrácie	Rez drážok v MDF: 5,0 m/s ²
Úroveň akustického tlaku	81 dB(A)
Úroveň akustického výkonu	92 dB(A)
Rozmery	110×269×260 mm
Hmotnosť	3,4 kg
Dĺžka privodného kábla	4,0 m



RP1110CJ
399,90 €

Horná fréza

RP0910 8 mm

303 

Príkon	900W
Upínacia klieština	8 mm
Max. hĺbka ponoru	0 – 57 mm
Voľnobežné otáčky	27.000
Vibrácie	Rez drážok v MDF: 8,0 m/s ²
Úroveň akustického tlaku	83 dB(A)
Úroveň akustického výkonu	94 dB(A)
Rozmery	110×269×260 mm
Hmotnosť	3,3 kg
Dĺžka privodného kábla	4,0 m



RP0910J
369,90 €

Horná fréza

RP0900 6 mm, 8 mm

106 

Príkon	900W
Max. hĺbka ponoru	0 – 35 mm
Voľnobežné otáčky	27.000
Vibrácie	Rez drážok v MDF: 4,0 m/s ²
Úroveň akustického tlaku	89 dB(A)
Úroveň akustického výkonu	100 dB(A)
Rozmery	110×256×217 mm
Hmotnosť	2,7 kg
Dĺžka privodného kábla	2,5 m



RP0900
139,90 €

Horná fréza

RP2300FC 12 mm

203 

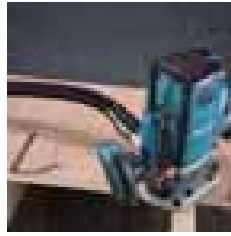

Prikon	2.300W
Upinacia klieština	12 mm alebo 1/2"
Max. hĺbka ponoru	0 – 70 mm
Voľnobežné otáčky	9.000 – 22.000
Vibrácie	Rez drážok v MDF: 4,5 m/s ²
Úroveň akustického tlaku	87 dB(A)
Úroveň akustického výkonu	98 dB(A)
Rozmery	155×294×312 mm
Hmotnosť	6,1 kg
Dĺžka privodného kábla	4,0 m

RP2300FCXJ
459,90 €

Horná fréza

RP1800F 12 mm

203 

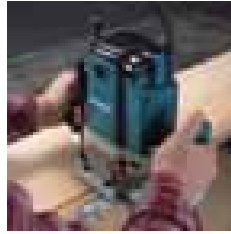

Prikon	1.850W
Upinacia klieština	12 mm alebo 1/2"
Max. hĺbka ponoru	0 – 70 mm
Voľnobežné otáčky	22.000
Vibrácie	Rez drážok v MDF: 4,0 m/s ²
Úroveň akustického tlaku	86 dB(A)
Úroveň akustického výkonu	97 dB(A)
Rozmery	155×294×312 mm
Hmotnosť	6 kg
Dĺžka privodného kábla	4,0 m

RP1800FXJ
399,90 €

Dlabačka

7104L

153 



Prikon	1.140W
Max. výkon	Max. šírka: 130 mm
	Max. hĺbka: 155 mm
Voľnobežné otáčky	3.200
Rozmery	512×298×513 mm
Hmotnosť	17,8 – 18,2 kg
Dĺžka privodného kábla	5,0 m

7104L
1 699,00 €

Dlabačka

KC100







Prikon	2.000 W
Max. hĺbka drážky	100 mm
Voľnobežné otáčky	4.500
Hmotnosť	12,8 kg

KC100
2 199,00 €



▣ ODSÁVANIE



-  Dvojitá izolácia
-  Nastavenie otáčok
-  Nerezová zberná nádoba
-  Flexibilná hadica
-  Antistatická hadica



Prikon	1.050W
Max. prietok vzduchu	2,0 m ³ / min
Max. podtlak	22,0 kPa
Vodný st/pec	(2.240 mmH ₂ O)
Objem nádrže	Prach: 32 L
	Voda: 27 L
Rozmery	552×398×685 mm
Hmotnosť	16,9 kg
Dĺžka privodného kábla	5,0 m

Dodávané s hadicou a nadstavcami na vysávanie

VC3211MX1
799,90 €



Prikon	1.050W
Max. prietok vzduchu	2,0 m ³ / min
Max. podtlak	22,0 kPa
Vodný st/pec	(2.240 mmH ₂ O)
Objem nádrže	Prach: 32 L
	Voda: 27 L
Rozmery	552×398×685 mm
Hmotnosť	14,5 kg
Dĺžka privodného kábla	5,0 m

Dodávané s hadicou a nadstavcami na vysávanie

VC3210LX1
499,90 €

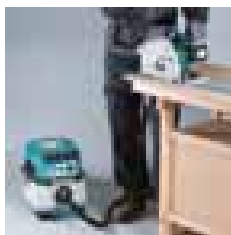

18V



AWS BL XPT
MOTOR EXTREME PROTECTION TECHNOLOGY

Objem nádrže	Prach: 8 L
Max. pracovný čas (min)	s BL1850B x2: 40
Max. prietok vzduchu	2,1 m ³ /min
Max. podtlak	9,8 kPa
Saci výkon	90 W
Vibrácie	2,5 m/s ²
Úroveň akustického tlaku	70 dB(A)
Rozmery	366×334×368 mm
Hmotnosť	7,7 – 8,4 kg

Dodávané s hadicou

DVC864LZX
399,90 €

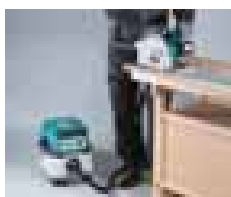

18V



BL XPT
MOTOR EXTREME PROTECTION TECHNOLOGY

Objem nádrže	Prach / voda: 8 / 6 L
Max. pracovný čas (min)	s BL1850B x2: 40
Max. prietok vzduchu	2,1 m ³ /min
Max. podtlak	9,8 kPa
Saci výkon	90 W
Vibrácie	2,5 m/s ²
Úroveň akustického tlaku	70 dB(A)
Rozmery	366×334×368 mm
Hmotnosť	7,0 – 7,6 kg

Dodávané s hadicou a nadstavcami na vysávanie

DVC862LZ
399,90 €

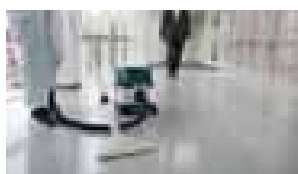

18V



Objem nádrže	Prach/Voda: 8 / 6 L
Max. pracovný čas (min)	s BL1850B x2: 65
Max. prietok vzduchu	AC / DC: 3,6 / 2,1 m ³ /min
Max. podtlak	AC / DC: 24 / 9 kPa
Saci výkon	AC / DC: 320 / 25 – 70 W
Vibrácie	2,5 m/s ²
Úroveň akustického tlaku	75 dB(A)
Rozmery	366×334×368 mm
Hmotnosť	8,6 – 9,2 kg

Dodávané s hadicou a nadstavcami na vysávanie

DVC860LZ
549,90 €

Vysávač

VC4210L / VC4210M / mokré & suché vysávanie/

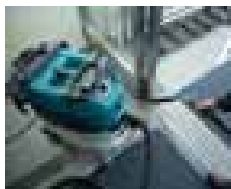
325 

EU trieda prašnosti	L / M
Príkon	1.400W
Max. prietok vzduchu	4,5 m ³ /min
Max. podtlak	25,0kPa
Objem nádrže	Prach: 34L Voda: 30L
Hlučnosť	60dB(A)
Rozmery	565x385x605
Hmotnosť	16,0kg
Dĺžka privodného kábla	7,5m

Dodávané s hadicou a nadstavcami na vysávanie

VC4210L
599,90 €VC4210M
699,90 €

Vysávač

VC3012L / VC3012M / mokré & suché vysávanie/

325 

EU trieda prašnosti	L / M
Príkon	1.500W
Max. prietok vzduchu	3,7 m ³ /min
Max. podtlak	25,0kPa
Objem nádrže	Prach: 24L Voda: 19L
Hlučnosť	59dB(A)
Rozmery	450x380x595
Hmotnosť	11,0kg
Dĺžka privodného kábla	7,5m

Dodávané s hadicou a nadstavcami na vysávanie

VC3012L
399,90 €VC3012M
619,90 €

Vysávač

VC2012L / VC2512L / VC3011L / mokré & suché vysávanie/

325 

EU trieda prašnosti	L	L	L
Príkon	1.000W	1.000W	1.000W
Max. prietok vzduchu	3,6 m ³ /min	3,6 m ³ /min	3,6 m ³ /min
Max. podtlak	21,0kPa	21,0kPa	21,0kPa
Objem nádrže	Prach: 15L Voda: 12L	Prach: 21L Voda: 18L	Prach: 26L Voda: 23L
Hlučnosť	72dB(A)	72dB(A)	72dB(A)
Rozmery	371x390x495	375x390x530	390x400x635
Hmotnosť	7,0 kg	7,0 kg	9,0kg
Dĺžka privodného kábla	7,5m	5 m	7,5m

Dodávané s hadicou a nadstavcami na vysávanie

VC2012L
239,90 €VC2512L
179,90 €VC3011L
259,90 €

Fukár

UB1103









303 

Príkon	600W
Max. prietok vzduchu	0 - 4,1 m ³ /min
Max. rýchlosť vzduchu	0 - 91 m/s
Tlak vzduchu	0 - 5,7 kPa
Voľnobežné otáčky	0 - 16.000
Vibrácie	2,5 m/s ²
Úroveň akustického tlaku	83 dB(A)
Úroveň akustického výkonu	94 dB(A)
Rozmery	479x185x178 mm
Hmotnosť	1,9 - 2,2 kg
Dĺžka privodného kábla	2,5 m

UB1103
79,90 €

▣ PNEUMATICKÉ NÁRADIE / OSTATNÉ



-  Nastavenie hĺbky
-  Nastavenie dávkovania klincov
-  Postupné dávkovanie
-  Drôtom spájané klince
-  Páskou spájané klince
-  Tichý mód
-  Vnútorný filter
-  Automatické odstavenie spúšte
-  Prepravný kufrík

Vysokotlaký kompresor AC310H



Príkon	1.800W
Max. tlak v nádrži	2,8 MPa (410 PSI)
Max. pracovný tlak	Vysoký tlak: 2,6 MPa (375 PSI) Nízky tlak: 0,9 MPa (130 PSI)
Pracovný výkon	2,5 HP
Objem tlakovej nádrže	6,2 L
Max. prítok vzduchu	90 L/min
Rozmery	476x507x375 mm
Hmotnosť	36 – 37 kg



AC310H
1 199,00 €

Kompresor AC1300



Príkon	2 100 W
Pracovný tlak	10 bar
Objem nádrže	20 l
Objem nasávania	240 l/min
Hmotnosť	26,5 kg

AC1300
449,90 €

Kompresor AC1350

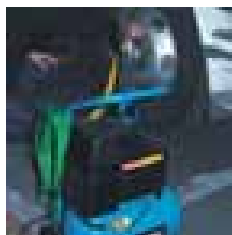

Príkon	2 100 W
Pracovný tlak	10 bar
Objem nádrže	50 l
Objem nasávania	240 l/min
Hmotnosť	26,5 kg

AC1350
499,90 €

Kompresor AC640



Príkon	1 460 W
Pracovný tlak	8 bar
Objem nádrže	6 l
Objem nasávania	170 l/min
Hmotnosť	14 kg

AC640
309,90 €

Kompresor MAC610



Príkon	1 100 W
Pracovný tlak	8 bar
Objem nádrže	6 l
Objem nasávania	160 l/min
Hmotnosť	8,5 kg

MAC610
249,90 €

Klincovačka

AN960



Dĺžka klincov	57 – 100 mm
Kapacita zásobníka	225 – 300
Pracovný tlak	0,49 – 0,83 MPa (71 – 120 PSI)
Rozmery	338×153×418 mm
Hmotnosť	5,1 kg



AN960
599,90 €

Klincovačka

AN902



Dĺžka klincov	45 – 90 mm
Kapacita zásobníka	150 – 300
Pracovný tlak	0,44 – 0,83 MPa (65 – 120 PSI)
Rozmery	408×131×316 mm
Hmotnosť	3,2 kg



AN902
499,90 €

Klincovačka

AN943



Dĺžka klincov	50 – 90 mm
Kapacita zásobníka	60 – 84
Pracovný tlak	0,44 – 0,83 MPa (65 – 120 PSI)
Rozmery	455×109×365 mm
Hmotnosť	4 kg



AN943K
439,90 €

Sponkovačka

AT638A

NOVINKA



Rozmer sponiek	Dĺžka: 13 – 38 mm
Sírka:	5,7 mm
Kaliber:	18 Ga
Pracovný tlak	0,49 – 0,83 MPa (70 – 120 PSI)
Kapacita zásobníka	100
Rozmery	230×75×251 mm
Hmotnosť	1,2 kg



AT638A
199,90 €

Sponkovačka

AT2550A



Rozmer sponiek	Dĺžka: 25 – 50 mm
Sírka:	25 mm
Kaliber:	16 Ga
Pracovný tlak	0,44 – 0,83 MPa (65 – 120 PSI)
Kapacita zásobníka	140
Rozmery	370×76×260 mm
Hmotnosť	2,3 kg



AT2550A
389,90 €

Sponkovačka

AT1150A



Rozmer sponiek	Dĺžka: 25 – 50 mm
	Šírka: 11 mm
	Kaliber: 16 Ga
Pracovný tlak	0,44 – 0,83 MPa (65 – 120 PSI)
Kapacita zásobníka	140
Rozmery	370×87×290 mm
Hmotnosť	2,3 kg

AT1150A
349,90 €

Klincovačka

AF201Z



Dĺžka klincov /piniek/	12 – 25 mm
Kapacita zásobníka	100
Pracovný tlak	0,44 – 0,86 MPa (65 – 125 PSI)
Rozmery	240×45×170 mm
Hmotnosť	0,9 kg

AF201Z
119,90 €

Klincovačka

AF505N



Dĺžka klincov	15 – 50 mm
	Kaliber: 18 Ga
Pracovný tlak	0,39 – 0,78 MPa (60 – 115 PSI)
Kapacita zásobníka	100
Rozmery	260×64×237 mm
Hmotnosť	1,4 kg

AF505N
89,90 €

Elektrická píla

UC3051A / UC3551A / UC4051A

153



Príkon	2.000W
Rychlosť rezače /min/	870m
Dĺžka lišty	UC3051A: 300mm UC3551A: 350mm UC4051A: 400mm
Delenie rezače / šírka drážky	3/8" / 1,3mm
Uroveň akustického tlaku / akustického výkonu	90,8dB(A) / 101,8dB(A)
Vibrácie	5,2m/s ²
Rozmery	505×200×220mm
Hmotnosť	UC3051A: 5,4 – 5,7 kg UC3551A: 5,5kg UC4051A: 5,6kg
Dĺžka prívodného kábla	0,3m

UC3051AX1
229,90 €

UC3551AX1
239,90 €

UC4051AX1
249,90 €

X1 – 2 rezače

Elektrická píla

UC3041A / UC3541A / UC4041A

153



Príkon	1.800W
Rychlosť rezače /min/	870m
Dĺžka lišty	UC3041A: 300mm UC3541A: 350mm UC4041A: 400mm
Delenie rezače / šírka drážky	3/8" / 1,1mm
Uroveň akustického tlaku / akustického výkonu	90,3dB(A) / 101,3dB(A)
Vibrácie	4,7 m/s ²
Rozmery	455×245×200mm
Hmotnosť	UC3041A: 4,6 – 4,7 kg UC3541A: 4,7 – 4,8 kg UC4041A: 4,8 – 4,9 kg
Dĺžka prívodného kábla	0,3m

UC3041A
129,90 €

UC3541A
139,90 €

UC4041A
149,90 €

4-taktná benzínová rozbrusovačka EK7651H 355mm



Priemer rezného kotúča	355mm
Obsah motora	75,6 cm ³
Max. hĺbka rezu	122mm
Voľnobežné otáčky	4.300
Obvodová rýchlosť	80m/s
Výkon motora	3,0kW / 4,1PS
Úroveň akustického tlaku	92,7dB(A)
Úroveň akustického výkonu	104,6dB(A)
Vibrácie ľavá predná / zadná rukoväť	2,7m/s ² / 1,8m/s ²
Objem palivovej nádrže	1,1L
Rozmery	780x310x455mm
Hmotnosť	14,2 kg

EK7651H
1 399,00 €

2-taktná benzínová rozbrusovačka EK7301 355 mm



Priemer rezného kotúča	355 mm
Obsah motora	73 cm ³
Max. hĺbka rezu	122 mm
Obvodová rýchlosť	80 m/s
Výkon motora	3,8 kW / 5,1 PS
Objem palivovej nádrže	1,1 L
Úroveň akustického tlaku	99,6 dB(A)
Úroveň akustického výkonu	109 dB(A)
Vibrácie ľavá predná rukoväť	7,0 m/s ²
Vibrácie pravá zadná rukoväť	4,9 m/s ²
Rozmery	770x290x370 mm
Hmotnosť	10,1 kg

EK7301WS
999,90 €

2-taktná benzínová rozbrusovačka EK8100 405 mm



Priemer rezného kotúča	405 mm
Obsah motora	81 cm ³
Max. hĺbka rezu	147 mm
Obvodová rýchlosť	80 m/s
Výkon motora	4,2 kW / 5,6 PS
Objem palivovej nádrže	1,1 L
Úroveň akustického tlaku	100,3 dB(A)
Úroveň akustického výkonu	109,6 dB(A)
Vibrácie ľavá predná rukoväť	7,8 m/s ²
Vibrácie pravá zadná rukoväť	6,1 m/s ²
Celková dĺžka	830 mm
Hmotnosť	10,6 kg

EK8100
1 099,00 €

Rezačka 4112HS 305 mm

210 mm



Priemok	2.400W
Max. rezný výkon	100 mm
Priemer rezného kotúča	305 mm
Voľnobežné otáčky	5.000
Celková dĺžka	648 mm
Hmotnosť	10,4 kg
Dĺžka privodného kábla	2,5 m

4112HS
619,90 €

Generátor EG2250A / EG2850A / EG4550A / EG5550A / EG6050A



	EG2250A	EG2850A	EG4550A	EG5550A	EG6050A
Objem palivovej nádrže	15L	15L	25L	25L	25L
Tým motora	170F	170F	190F	190F	190F
Obsah motora	210 cm ³	210 cm ³	420 cm ³	420 cm ³	420 cm ³
Menovitý výkon	50Hz : 2,0kVA	50Hz : 2,6kVA	50Hz : 4,0kVA	50Hz : 5,0kVA	50Hz : 5,5kVA
Maximálny výkon VA	50Hz : 2,2kVA	50Hz : 2,8kVA	50Hz : 4,5kVA	50Hz : 5,5kVA	50Hz : 6,0kVA
Rozmery	600x442x450mm	600x442x450mm	680x550x550mm	680x550x550mm	680x550x550mm
Hmotnosť	49,8kg	52,8kg	95,5kg	98,5kg	100,5kg

EG2250A
699,90 €

EG2850A
799,90 €

EG4550A
1 099,00 €

EG5550A
1 159,00 €

EG6050A
1 199,00 €

Vysokotlakový čistič

HW1200



Príkon	1.800W
Max. tlak	12 MPa (120 bar. 1.740 PSI)
Max. prietok vody	420 L/h
Max. teplota privádzanej vody	40 °C
Dĺžka vysokotlakovej hadice	10 m
Úroveň akustického tlaku	72 dB(A)
Vibrácie	4,11 m/s ²
Rozmery	292x358x830 mm
Hmotnosť	11,0 kg
Dĺžka privodného kábla	5,0 m



HW1200
259,90 €

Vysokotlakový čistič

HW1300



Príkon	1.800W
Max. tlak	13 MPa (130 bar. 1.885 PSI)
Max. prietok vody	420 L/h
Max. teplota privádzanej vody	40 °C
Dĺžka vysokotlakovej hadice	10 m
Úroveň akustického tlaku	76 dB(A)
Vibrácie	4,86 m/s ²
Rozmery	292x358x830 mm
Hmotnosť	12,7 kg
Dĺžka privodného kábla	5,0 m



HW1300
299,90 €

Vysokotlakový čistič

HW102 / HW111 / HW132 / HW151



	HW102	HW111	HW132	HW151
Príkon	1.300W	1.700W	2.100 W	2.500 W
Max. tlak	10 MPa (100 bar. 1.450 PSI)	11 MPa (110 bar. 1.595 PSI)	14 MPa (140 bar)	15 MPa (150 bar. 2.175 PSI)
Max. prietok vody	360 L/hr	370 L/hr	420 L/hr	500 L/hr
Typ motora	Univerzálny	Univerzálny	Indukčný	Indukčný
Úroveň akustického tlaku	85,74 dB(A)	79,15 dB(A)	80,1 dB(A)	80,1 dB(A)
Úroveň akustického výkonu	94 dB(A)	87 dB(A)	88 dB(A)	88 dB(A)
Max. teplota privádzanej vody	50 °C	50 °C	50 °C	50 °C
Dĺžka vysokotlakovej hadice	5 m	5,5 m	8 m	10 m
Hmotnosť	5,8 kg	7,4 kg	18,8 kg	26,9 kg

HW102
109,90 €

HW111
199,90 €

HW132
359,90 €

HW151
699,90 €

Ponorné čerpadlá

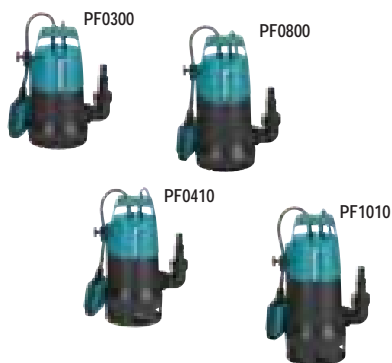
PF0300 / PF0410 / PF0800 / PF1010 **NOVINKA**

	PF0300	PF0410	PF0800	PF1010
Príkon	300 W	400 W	800 W	1 100 W
Max. prietok	140 L	140 L	220 L	240 L
Max. výtlak	7 m	5 m	9 m	10 m
Max. hĺbka ponoru	5 m	5 m	5 m	5 m
Max. výtlak	7 m	5 m	9 m	10 m
Min. sacia hĺbka	20 mm	40 mm	20 mm	40 mm
Max. veľkosť nečistôt	5 mm	35 mm	5 mm	35 mm
Rozmery	160x168x305	160x168x345	160x168x340	160x168x380
Hmotnosť	4,2 kg	4,3 kg	6,1 kg	6,6 kg
Dĺžka privodného kábla	10 m	10 m	10 m	10 m

PF0300
64,90 €

PF0410
69,90 €

PF0800
86,90 €

PF1010
94,90 €

Tepl vzdušná pištoľ

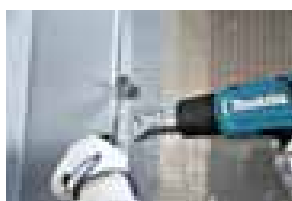
HG5030K **NOVINKA**

Príkon	1 600 W
Teplota vzduchu	350 – 500 °C
Max. prietok vzduchu	300 – 500 L/min
Hmotnosť	0,56 kg
Dĺžka privodného kábla	2,0 m



HG5030K
69,90 €



Prikon	1 800 W
Teplota vzduchu	50 – 600 °C
Max. prietok vzduchu	250 – 500 L/min
Hmotnosť	0,67 kg
Dĺžka privodného kábla	2,0 m

HG6031VK
119,90 €



Prikon	2 000 W
Teplota vzduchu	50 – 650 °C
Max. prietok vzduchu	200 – 550 L/min
Hmotnosť	0,72 kg
Dĺžka privodného kábla	2,0 m

HG6531CK
139,90 €



CXT XPT
EXTREME PROTECTION TECHNOLOGY



Presnosť merania	±1 mm / 10 m
Samonivelizácia	±2°
Uhol lasera	Horizontal: 110° Vertical: 130°
Počet laserových línií	3
Typ lasera	Laser class 2: 515 nm
Pracovná teplota	-10 – 40 °C
Uchytenie stavivu	5/8"
Trieda ochrany	IP54
Pracovný čas cca	10–28
Rozmery	s BL1016/BL1021B: 122×110×225 mm s BL1041B: 122×130×225 mm
Hmotnosť	1,5 – 1,6 kg

SK312GDZ
1 499,00 €



Max. dosah merania	do 15 m
Max. dosah merania s detektorom	do 60 m
Presnosť merania	±3 mm / 10 m
Samonivelizácia	4±1°
Počet laserových bodov	4 (horná, dolná, ľavá, pravá)
Počet laserových línií	2 (horizontálna, vertikálna)
Typ lasera	Trieda lasera 2: 635 nm
Pracovná teplota	-10 – 40 °C
Skladovacia teplota	-25 – 70 °C
Uchytenie stavivu	1/4"
IP ochrana	IP54
Max. pracovný čas	cca 35 hodín
Hmotnosť	0,53 kg

SK103PZ
359,90 €



Max. dosah merania	do 15 m
Max. dosah merania s detektorom	do 60 m
Presnosť merania	±3 mm / 10 m
Samonivelizácia	4+ – 1°
Počet laserových bodov	4
Počet laserových línií	2
Typ lasera	Trieda lasera 2: 635 nm
Pracovná teplota	-10 – 40 °C
Skladovacia teplota	-25 – 70 °C
Uchytenie stavivu	1/4"
IP ochrana	IP54
Hmotnosť	0,53 kg

SK104Z
199,90 €

Samonivelizačný laser

SKR200Z



Max. dosah merania (priemer)	200 m
Rýchlosť otáčok	0, 300, 450, 600
Presnosť merania	±1 mm / 10 m
Samonivelizácia	±6°
Napájanie	2x1,5 Ah aku
Max. pracovný čas	60 hod.
Hmotnosť	1,6 kg

SKR200Z
799,90 €

Laserový diaľkomer

LD030P



Max. dosah merania	0,2 – 30 m
Pracovná teplota	0 – 40 °C
Skladovacia teplota	-25 – 70 °C
Priemerná presnosť merania	±2,0 mm / 10 m
Max. presnosť merania	±3,0 mm / 10 m
Priemer laserového bodu	6 mm / 10 m
Typ laseru	Trieda laseru 2: 635 nm
Rozmery	117x53x25 mm
Hmotnosť	0,1 kg

LD030P
79,90 €

Laserový diaľkomer

LD080PI



Max. dosah merania	0,05 – 80 m
Napájanie	2xAAA 1,5 V aku
Hmotnosť	0,14 kg

LD080PI
199,90 €

Laserový diaľkomer

LD050P

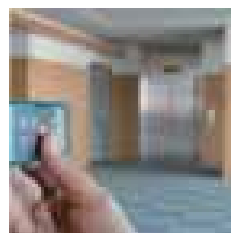

Max. dosah merania	0,05 – 50 m
Napájanie	2xAAA 1,5 V aku
Hmotnosť	0,1 kg

LD050P
99,90 €



▣ SETY NÁRADIA



DLX2126TJ1



DGA504Z + DHP480Z +
2 ks 5,0 Ah + DC18RC +
systainer

DLX2126TJ1
649,90 €

CLX201SAX6



DF331DZ + TD110DZ +
2 ks 2,0 Ah + DC10SA +
chladiaci box

CLX201SAX6
239,90 €

DLX2133



DHP482Z + DTW251Z +
2 ks 3,0 Ah + DC18RC +
kufor

DLX2133
439,90 €

DK0053G



GA9020 + 9558HNRG +
kufor

DK0053G
219,90 €

DLX2153TJ1



DGA504Z + DHR241Z +
2 ks 5,0 Ah + DC18RC +
systainer

DLX2153TJ1
599,90 €

MEU029J



SP6000 + 4351FCT +
kufor

MEU029J
579,90 €

DLX3078TX1



DGA504Z + DHR241Z +
DDF482Z + 3 ks 5,0 Ah +
DC18RC + taška

DLX3078TX1
799,90 €

Set



DDF485RFJ +
632G12-3 (18 V, 3,0 Ah)

DDF485RFJ + 632G12-3
369,90 €

DLX6037



DTD152Z + DGA452Z +
DSS610Z + DJR186Z +
DHP458Z + DML802 +
3 ks 3,0 Ah + DC18RC +
taška

DLX6037
899,90 €

Set



DHP485RFJ + DTD171Z

DHP485RFJ + DTD171Z
479,90 €



DCL180Z + 195584-2 + 632B42-4
169,90 €



DDF453RFE + DLC180Z
299,90 €



DLX2126TJ1 + TR00000001
749,90 €



HR5212C + DMR108
1 099,00 €



LS1019L + RP1800FXJ
1 099,00 €



DF331DSAE + CL108FDZ
189,90 €

Do vypredania zásob



HR2470T + GA4530R
289,90 €



HR2630 + GA5030R
229,90 €



HR2630T + GA9060R
379,90 €

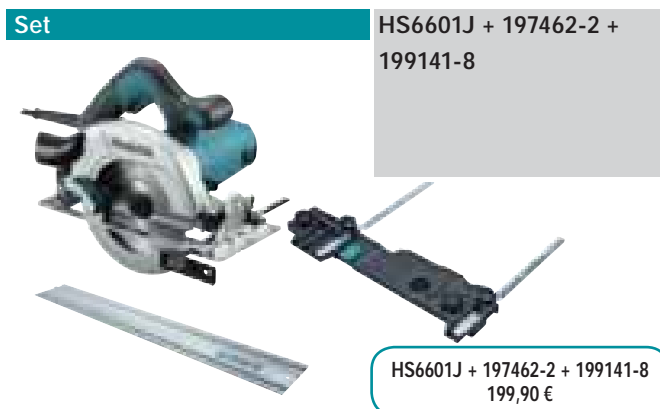

HS6601J + 197462-2 + 199141-8
199,90 €

Set SG150 + VC4210L



SG150 + VC4210L
1 499,00 €

Set KP0800 + 824892-1



KP0800 + 824892-1
149,90 €

Set DBM230 + P-54190



DBM230 + P-54190
2 199,00 €

Set MAC610 + AF505N + P-45973



MAC610 + AF505N + P-45973
359,90 €



Makita®

mt

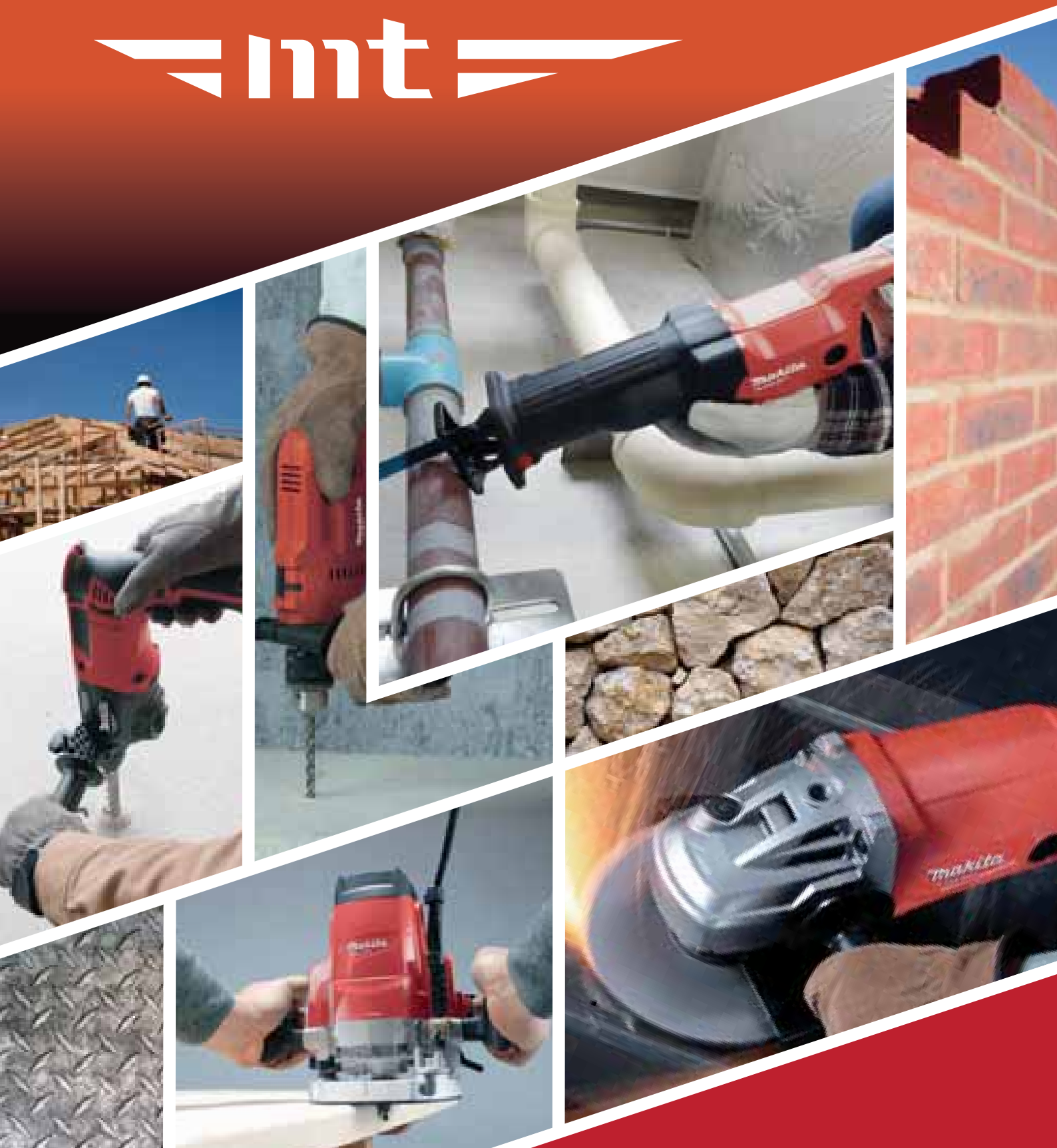

Vrtačka

M6002 10 mm



Príkon	450 W
Max. vrtací výkon	železo: 10 mm
	drevo: 25 mm
Voľnobežné otáčky	0–3 000 min ⁻¹
Rozmery	234×64×175 mm
Hmotnosť	1,3 kg
Dĺžka privodného kábla	2,0 m
Rozsah upínania skľučovadla	0,8–10 mm

M6002
44,90 €

Miešadlo

M6600



Príkon	800 W
Voľnobežné otáčky	0–700 min ⁻¹
Uchytenie nástroja	M12 alebo M14
Rozmery	280×86×388 mm
Hmotnosť	3,4 kg
Dĺžka privodného kábla	2,0 m

M6600
89,90 €

Príklepová vrtačka

M8103 13 mm

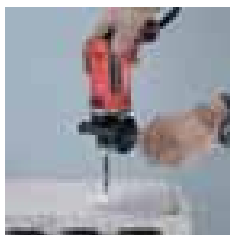

Príkon	430 W
Max. vrtací výkon	betón: 13 mm
	železo: 13 mm
	drevo: 18 mm
Voľnobežné otáčky	0–3 000 min ⁻¹
Frekvencia príklepu	0–33 000 min ⁻¹
Rozmery	255×72×193 mm
Hmotnosť	1,8 kg
Dĺžka privodného kábla	2,0 m

M8103
59,90 €

Kombinované kladivo SDS Plus M8700 22 mm



Príkon	710 W
Max. vrtací výkon	betón: 22 mm
	železo: 13 mm
	drevo: 32 mm
Frekvencia príklepu	0–4 350
Voľnobežné otáčky	0–1 100 min ⁻¹
Rozmery	362×71×194 mm
Hmotnosť	2,5 kg
Dĺžka privodného kábla	5,0 m

M8700
99,90 €

Kombinované kladivo SDS Plus M8701Z

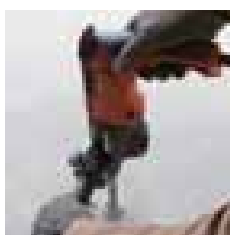

Príkon	800 W
Síla jednotlivého príklepu	EPTA-Procedure 05/2009 : 2,3 J
Max. vrtací výkon betón	betón: 26 mm
Max. vrtací výkon železo	železo: 13 mm
Max. vrtací výkon drevo	drevo: 32 mm
Frekvencia príklepu	0–4 500
Voľnobežné otáčky	0–1 200 min ⁻¹
Rozmery	362×71×194 mm
Hmotnosť	2,7 kg
Dĺžka privodného kábla	5,0 m

M8701Z
109,90 €

Uhlová brúska

M9502R 115 mm

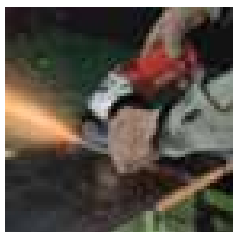

Prikon	570 W
Priemer kotúča Ø	115 mm
Voľnobežné otáčky	11 000 min ⁻¹
Rozmery	281×130×110 mm
Hmotnosť	2,0 kg
Dĺžka privodného kábla	2,0 m

M9502R
57,90 €

Uhlová brúska

M9503R 125 mm

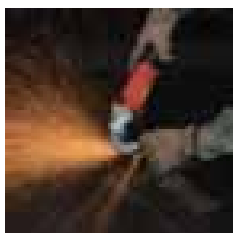

Prikon	570 W
Priemer kotúča Ø	125 mm
Voľnobežné otáčky	11 000 min ⁻¹
Rozmery	281×140×110 mm
Hmotnosť	2,1 kg
Dĺžka privodného kábla	2,0 m

M9503R
59,90 €

Uhlová brúska

M9001 230 mm



Prikon	2 000 W
Rozmer brúsneho pásu	230 mm
Rychlosť brúsneho pásu	6 600 min ⁻¹
Rozmery	466×250×138 mm
Hmotnosť	5,7 kg
Dĺžka privodného kábla	2,0 m

M9001
109,90 €

Pásová brúska

M9400 100 mm



Prikon	940 W
Rozmer brúsneho pásu	100×610 mm
Rychlosť brúsneho pásu	380 m/min.
Rozmery	354×175×169 mm
Hmotnosť	6,2 kg
Dĺžka privodného kábla	2,0 m

M9400
149,90 €

Excentrická brúska

M9204 125 mm

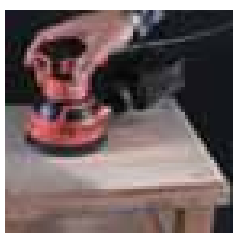

Prikon	240 W
Priemer brúsnej plochy	123 mm
Priemer brúsneho papiera	125 mm
Voľnobežné otáčky za min.	12 000
Počet kmitov za minútu	24 000
Priemer okruhu	2,8 mm
Rozmery	153×123×144 mm
Hmotnosť	1,2 kg
Dĺžka privodného kábla	2,0 m

M9204
64,90 €

Vibračná brúska

M9203

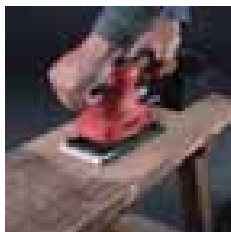

Príkon	190 W
Priemer brúsnej plochy	92×185 mm
Priemer brúsneho papiera	93×228 mm
Voľnobežné otáčky za min.	12 000
Počet kmitov za minútu	24 000
Priemer okruhu	2,0 mm
Rozmery	252×92×154 mm
Hmotnosť	1,4 kg
Dĺžka privodného kábla	2,0 m



M9203
59,90 €

Rezačka na železo 355 mm

M2401

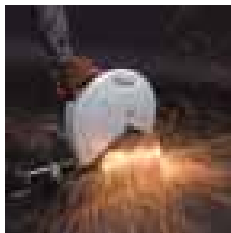

Príkon	2 000 W
Priemer kotúča	355 mm
Vrtanie kotúča	25,4 mm
Max. hrúbka kotúča	3 mm
Voľnobežné otáčky	3 900 min ⁻¹
Hmotnosť	15,3 kg
Dĺžka privodného kábla	2,5 m



M2401
159,90 €

Kotúčová píla

M5802 190 mm, 185 mm

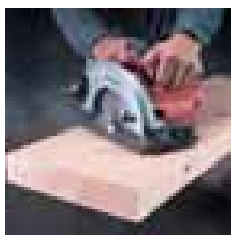

Príkon	1 050 W
Priemer kotúča	190 / 185 mm
Max. rezný výkon	pri 90°: 68 / 66 mm
	pri 45°: 46 / 44 mm
Voľnobežné otáčky	4 900 min ⁻¹
Celková dĺžka	297 mm
Hmotnosť	4,0 kg
Dĺžka privodného kábla	2,0 m



M5802
99,90 €

Priamočiara píla

M4301



Príkon	450 W
Max. rezný výkon	drevo: 65 mm
	železo: 6 mm
Dĺžka zdvihu	18 mm
Počet zdvihov za minútu	0-3 100
Rozmery	214×75×202 mm
Hmotnosť	1,9 kg
Dĺžka privodného kábla	2,0 m



M4301
59,90 €

Chvostová píla

M4501K



Príkon	1 010 W
Dĺžka zdvihu	28 mm
Počet zdvihov za minútu	0-2 800
Max. rezný výkon	rúra: 130 mm
	drevo: 255 mm
Rozmery	457×98×170 mm
Hmotnosť	3,2 kg
Dĺžka privodného kábla	2,0 m



M4501K
109,90 €

Chvostová píla

M4500K

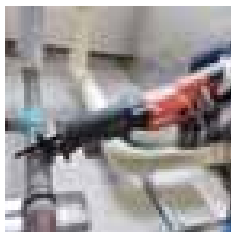

Prikon	1 010 W
Dĺžka zdvihů	28 mm
Poččet zdvihův za minútu	0-2 800
Max. rezný výkon	rúra: 130 mm drevo: 255 mm
Rozmery	457×98×174 mm
Hmotnosť	3,1 kg
Dĺžka privodného kábla	2,0 m

M4500K
104,90 €

Horná fréza

M3600 12 mm



Prikon	1 650 W
Upínacia klieština	klieština: 12 mm alebo 1/2"
Max. zanorenie	0-60 mm
Rozmer spodnej platne	160×148mm
Voľnobežné otáčky	22 000 min ⁻¹
Rozmery	284×148×300 mm
Hmotnosť	5,5 kg
Dĺžka privodného kábla	2,0 m

M3600
149,90 €

Horná fréza so zanorením

M3601 6 mm, 8 mm



Prikon	900 W
Upínacia klieština	6 mm, 8 mm (dodávané so 6 mm klieštinou)
Max. zanorenie	0-35 mm
Voľnobežné otáčky	27,000 min ⁻¹
Celková výška	256 mm
Hmotnosť	2,7 kg
Dĺžka privodného kábla	2,0 m

M3601
89,90 €

Hoblík

M1902 82 mm



Prikon	500 W
Šírka záberu	82 mm
Hrúbka triesky	1 mm
Hĺbka drážky	9 mm
Voľnobežné otáčky	16 000 min ⁻¹
Rozmery	285×157×160 mm
Hmotnosť	2,7 kg
Dĺžka privodného kábla	2,0 m

M1902
79,90 €

Hoblík

M1901 82 mm



Prikon	500 W
Šírka záberu	82 mm
Hrúbka triesky	2 mm
Hĺbka drážky	9 mm
Voľnobežné otáčky	16 000 min ⁻¹
Celková dĺžka	285 mm
Hmotnosť	2,7 kg
Dĺžka privodného kábla	2,0 m

M1901
99,90 €



Kompatibilita akumulátorov pre rádiá

Model	Bluetooth	DAB+	DAB	Made for iPod iPhone	USB	LXT		CXT		18V G Li-ion	14.4V G Li-ion	18V-9.6V Ni-MH / Ni-Cd	
						18V Li-ion	14.4V Li-ion	12Vmax Li-ion	10.8V Li-ion				7.2V Li-ion
DMR112	✓	✓	✓		✓	—	—	✓	✓	✓	—	—	—
DMR110		✓	✓			✓	✓	✓	✓	✓	—	—	—
DMR109			✓			✓	✓	✓	✓	✓	—	—	—
DMR108	✓					✓	✓	✓	✓	✓	—	—	—
DMR107						✓	✓	✓	✓	✓	—	—	—
DMR106	✓					✓	✓	—	✓	✓	✓	✓	—
DMR050						✓	✓	—	—	—	—	—	—
DMR052						—	—	✓	—	—	—	—	—
DMR200	✓					✓	✓	✓	—	—	—	—	—
DMR201	✓				✓	✓	✓	✓	—	—	—	—	—
DMR202	✓				✓	✓	✓	✓	—	—	—	—	—

AWS

Auto - start Wireless System

Zapnite stroj



Vysávač
je aktivovaný

DLS111

DSP601

DGA512

DHR400

DVC864L



AWS aktivuje vysávač po zapnutí stroja cez Bluetooth

Slovná ochranná známka Bluetooth® a logá sú registrovanými ochrannými značkami vo vlastníctve spoločnosti Bluetooth SIG, Inc. A akékoľvek používanie takýchto známk spoločnosťou Makita podlieha licenci. Ostatné ochranné známky a obchodné názvy patria ich príslušným vlastníkom.

VYSVETLIVKY

18 V / 12 V MAX program

Z	– dodávané bez akumulátora a nabíjačky
J	– dodávané v systainery
K	– dodávané v kufri
X	– extra príbal príslušenstva
PT2	– Dvojnabíjačka /rýchlonabíjačka/, 2 ks 5,0 Ah akumulátor
PT4	– Dvojnabíjačka /rýchlonabíjačka/, 4 ks 5,0 Ah akumulátor
PF2	– Rýchlonabíjačka, 2 ks 3,0 Ah akumulátor
RF	– Rýchlonabíjačka, 1 ks 3,0 Ah akumulátor
SYE	– Nabíjačka, 2 ks 1,5 Ah akumulátor
RFJ	– Rýchlonabíjačka, 2 ks 3,0 Ah akumulátor, systainer
RFE	– Rýchlonabíjačka, 2 ks 3,0 Ah akumulátor
RTE	– Rýchlonabíjačka, 2 ks 5,0 Ah akumulátor
RTJ	– Rýchlonabíjačka, 2 ks 5,0 Ah akumulátor, systainer
RF3J	– Rýchlonabíjačka, 3 ks 3,0 Ah akumulátor, systainer
RFEB	– Rýchlonabíjačka, 2 ks 3,0 Ah akumulátor, čierne prevedenie stroja
RTJV	– Rýchlonabíjačka, 2 ks 5,0 Ah akumulátor, systainer, odsávacie zariadenie
DZ	– dodávané bez akumulátora a nabíjačky
DSAE	– Rýchlonabíjačka, 2 ks 2,0 Ah akumulátor
DSME	– Rýchlonabíjačka, 2 ks 4,0 Ah akumulátor

Označenie akumulátorov

Y	– 1,5 Ah
A	– 2,0 Ah
F	– 3,0 Ah
M	– 4,0 Ah
T	– 5,0 Ah
G	– 6,0 Ah

ADT

– Automatická regulácia otáčok

AFT

– Automatické zastavenie stroja

DXT

– presný rez

Deep and Exact Cutting Technology

XPT

– ochrana proti zvýšenej prašnosti a vlhkosti

EXTREME PROTECTION TECHNOLOGY

SJST

– antivibračný systém

SUPER JOINT SYSTEM

AWS

– prepojenie aku strojov s aku vysávačom

AVT

– antivibračný systém

ANTI VIBRATION TECHNOLOGY

BL

– bezuhlíkový motor

MOTOR



– brzda

Katalóg strojov Makita



Makita®

Makita s. r. o.
Jegorovova 35, 974 01 Banská Bystrica
Tel.: 048 – 4161 772, Fax: 048 – 4161 769
Servis: 048 – 4161 774
makita@makita.sk
www.makita.sk



LXI CXI MM4
RoHS REACH